

KNX

Digitally Addressable Lighting Interface (DALI-2)

USER MANUAL

Issue date: 06/2020 r1.1 ENGLISH

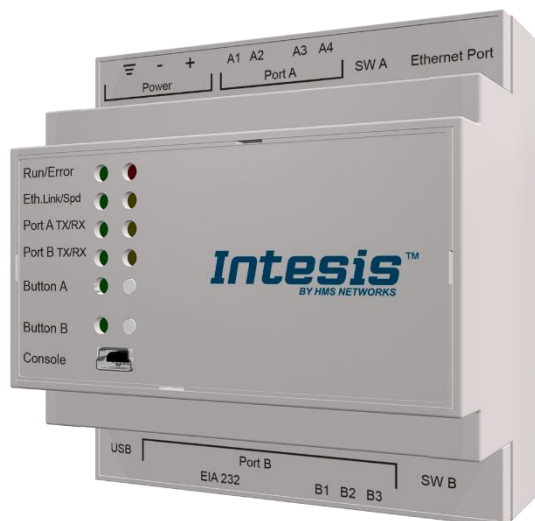

Important User Information

Disclaimer

The information in this document is for informational purposes only. Please inform HMS Industrial Networks of any inaccuracies or omissions found in this document. HMS Industrial Networks disclaims any responsibility or liability for any errors that may appear in this document.

HMS Industrial Networks reserves the right to modify its products in line with its policy of continuous product development. The information in this document shall therefore not be construed as a commitment on the part of HMS Industrial Networks and is subject to change without notice. HMS Industrial Networks makes no commitment to update or keep current the information in this document.

The data, examples and illustrations found in this document are included for illustrative purposes and are only intended to help improve understanding of the functionality and handling of the product. In view of the wide range of possible applications of the product, and because of the many variables and requirements associated with any particular implementation, HMS Industrial Networks cannot assume responsibility or liability for actual use based on the data, examples or illustrations included in this document nor for any damages incurred during installation of the product. Those responsible for the use of the product must acquire sufficient knowledge in order to ensure that the product is used correctly in their specific application and that the application meets all performance and safety requirements including any applicable laws, regulations, codes and standards. Further, HMS Industrial Networks will under no circumstances assume liability or responsibility for any problems that may arise as a result from the use of undocumented features or functional side effects found outside the documented scope of the product. The effects caused by any direct or indirect use of such aspects of the product are undefined and may include e.g. compatibility issues and stability issues.

Gateway for integration of DALI devices into KNX TP-1 home and building automation systems.

ORDER CODE
INKNXDAL0640200

INDEX

- 1 Description5
 - 1.1 Introduction.....5
 - 1.2 Functionality6
 - 1.3 Gateway's capacity6
- 2 DALI Interface7
 - 2.1 Characteristics.....7
- 3 KNX interface8
 - 3.1 Description.....8
 - 3.2 Points definition8
 - 3.3 KNX Communication Objects.....9
 - 3.3.1 Single DALI device signals9
 - 3.3.2 DALI groups' signals.....16
 - 3.3.3 Broadcast signals18
 - 3.3.4 Input Devices signals.....20
- 4 Connections21
 - 4.1 Powering the device22
 - 4.2 Connection to DALI channel.....22
 - 4.3 Connection to KNX.....22
 - 4.4 Connection to PC (Configuration tool)22
- 5 Status LEDs and push buttons23
- 6 Set-up process and troubleshooting24
 - 6.1 Pre-requisites24
 - 6.2 Intesis MAPS. Configuration & monitoring tool for Intesis24
 - 6.2.1 Introduction24
 - 6.2.2 Connection.....24
 - 6.2.3 Configuration tab25
 - 6.2.4 Signals26
 - 6.2.5 Sending the configuration to Intesis26
 - 6.2.6 Diagnostic27
 - 6.3 Set-up procedure.....29
- 7 Electrical & Mechanical Features.....30
- 8 Dimensions31
- Annex A – Quick setup and commissioning of a DALI network32
 - 8.1 Create project33
 - 8.2 Device declaration in project33
 - 8.3 Scan and commissioning of devices35

1 Description

1.1 Introduction

This document describes the integration of DALI-2 lighting ballasts and sensors into KNX TP-1 home automation systems using the Intesis KNX to DALI communication gateway.

The aim of this integration is to monitor and control DALI lighting ballasts and sensors (see section 2 for specific DALI parts), remotely, from a KNX home automation system, as if it was a part of the own KNX installation and vice-versa.

Up to 64 addresses for DALI lighting devices (ECGs), and another 64 addresses for Sensors can be fitted in a single DALI channel, and therefore controlled and monitored from Intesis gateway.

Intesis needs to be configured using Intesis MAPS software configuration tool. In the software, KNX and DALI lighting ballast parameters must be configured and downloaded to the Intesis gateway.

This document assumes the user is familiar with KNX and DALI technologies and technical terms.



NOTE: Intesis is compatible with Ballasts and sensors implementing DALI-2 standard and certified under DiiA guidelines for testing and certification. Use only DALI-2 devices having the DALI-2 logo with Intesis.

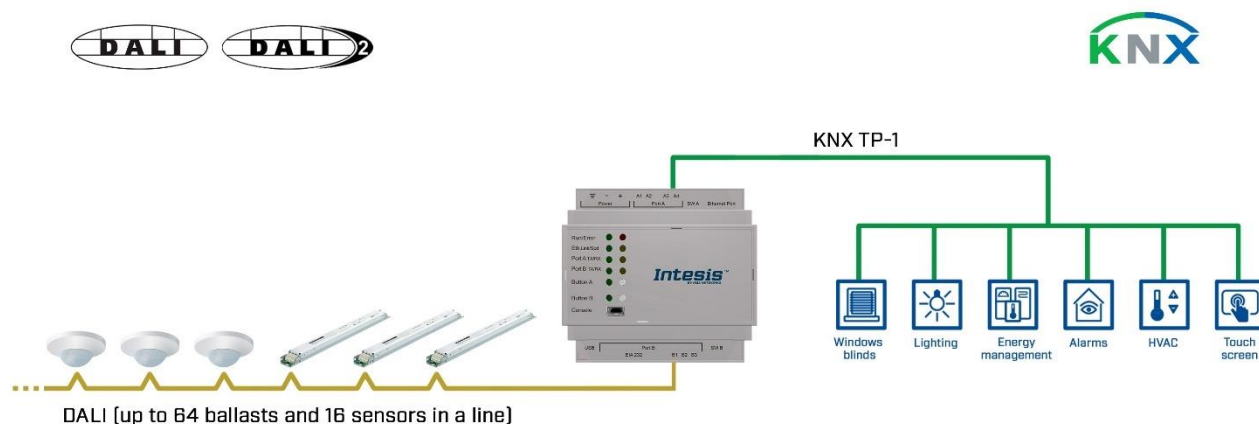

Integration of DALI into KNX TP-1 home or building automation system

1.2 Functionality

Intesis™ continuously polls (reads) all the signals of the DALI ECGs and sensors to obtain updated values to be served in KNX.

Each of the mentioned DALI point is associated to a *KNX group address*, with this, the DALI system is seen as *one more KNX device* from the KNX system point of view, with the same configuration and operation characteristics

When a change in any DALI point occurs, a write telegram is sent to the KNX bus, of the associated *KNX Group*. See details in section 3.

When a telegram is received from the KNX bus, of a *KNX Group address* associated to a DALI point, a message is sent immediately to the corresponding DALI lighting device to perform the corresponding action.

In the continuous polling process of the DALI channel, if there is no answer, it is indicated with a virtual signal of communication error for this ballast in its line.

The KNX physical address address and all relative KNX group addresses must be set in the MAPS configuration tool.

From the configuration tool, it is also possible to scan each DALI channel for available ECGs and/or sensors, add them in configuration, and configure its individual parameters (short address, preset levels, scenes, etc), according to their device type or instance.

1.3 Gateway's capacity

Intesis capacity is listed below:

Element	Max.	Notes
Number of DALI channels	1	Number of independent DALI channels
Number DALI ECG addresses per line	64	64 DALI ECG addresses are supported per line
Number DALI Sensor addresses per line	64	64 DALI Sensor addresses are supported per line <small>The maximum number of devices is limited by the guaranteed power supply of the DALI network. Keep in mind when dimensioning each DALI channel. See Section 2 for more details.</small>
Max number of KNX variables per DALI device	61	Number of available signals will vary according to device type
Max number of KNX variables per DALI group	16	Number of available signals will vary according to device type
Max number of variables per LINE	4176	16 broadcast signals + 16 signals/DALI group + 61 signals/DALI device

2 DALI Interface

Intesis gateway and its DALI interface complies with the new DALI-2 (IEC62386) standard thanks to its DALI-2 certification.

Intesis gateway enables the connection of up to 64 DALI/DALI-2 ECGs and 64 DALI-2 sensors. In current version of the device, the following device types are supported:

- General requirements (Part 101)
 - Part 201: DALI Fluorescent lamps (DALI type 0)
 - Part 202: Self-contained Emergency lighting (DALI type 1)
 - Part 207: LED modules (DALI type 6)
 - Others (Multiple DALI types)
- Sensors (Part 103):
 - Part 303: DALI-2 Occupancy sensors
 - Part 304: DALI-2 Light sensors

The maximum number of DALI devices (ECGs and/or input devices) depends on the sum current consumption of the specific devices. Intesis gateway supplies bus power of 235 mA for power supply of the DALI devices, so if all input devices (sensors) in the bus consumed 5 mA then we could connect 64 ECGs (standard defines max. consumption allowed for these devices is 2mA) and 16 sensors.

$$64 \text{ ECGs} * 2 \text{ mA} + 16 \text{ sensors} * 5 \text{ mA} = 208 \text{ mA} < 235 \text{ mA} * 90\%$$

As the standard recommends, don't use the guaranteed current to calculate the maximum number of DALI devices, leave 10% of the current for dynamic processes into account.

2.1 Characteristics

Element	Values
DALI voltage (V)	14 V – 17 V; typically, 16V
Guaranteed current (mA) available per line	235
Maximum Current (mA) available per line	250
Start-up time (ms)	1500
Shutdown time (sec)	7
Data transfer rate (bauds)	1200

3 KNX interface

In this section, a common description for all Intesis KNX series gateways is given, from the point of view of KNX system which is called from now on *internal system*. The DALI system is also called from now on *external system*.

3.1 Description

Intesis KNX connects directly to the KNX TP-1 (EIB) bus and behaves as one more device into the KNX system, with the same configuration and operational characteristics as other KNX devices.

Internally, the circuit part connected to the KNX bus is opto-isolated from the rest of the electronics.

Intesis-KNX receives, manages and sends all the telegrams related to its configuration to the KNX bus.

On receiving telegrams of KNX Groups associated to internal datapoints, the corresponding messages are sent to the external system (DALI) to maintain both systems synchronised in every moment.

When a change in a signal of the external system is detected, a telegram is sent to the KNX bus (of the associated KNX group) to maintain both systems synchronised in every moment.

The status of the KNX bus is checked continuously and, if a bus drops down is detected, due to a failure in the bus power supply for example, when the KNX bus is restored again, Intesis will retransmit the status of all the KNX groups marked as "T" *Transmit*. Also *Updates* for the groups marked as "U" will be performed on corresponding Group Address. The behaviour of each individual point into Intesis is determined by the flags configured for the point. See details in section below.

3.2 Points definition

Every internal datapoint to define has the following KNX properties:

Property	Description
Description	Descriptive information about the Communication Object or Signal.
Signal	Signal's Description. Only for informative purposes, allows identifying the signal comfortably.
DPT	It is the KNX data type used to code the signal's value. It will depend on the type of signal associated in the external system in every case. In some integrations, it is selectable, in others it is fixed due to the intrinsic characteristics of the signal.
Group	It is the KNX group to which the point is associated. It is also the group to which the read (R), write (W), transmit (T) and update (U) flags are applied. Is the sending group.
Listening addresses	They are the addresses that will actuate on the point, apart of the main Group address.
R	Read. If this flag is activated, read telegrams of this group address will be accepted.
Ri	Read. If this flag is activated, the object will be read on initialization.
W	Write. If this flag is activated, write telegrams of this group address will be accepted.
T	Transmit. If this flag is activated, when the point's value changes, due to a change in the external system, a write telegram of the group address will be sent to the KNX bus.
U	Update. If this flag is activated, on Intesis start-up or after a KNX bus reset detection, objects will be updated from KNX.
Active	If activated, the point will be active in Intesis, if not, the behaviour will be as if the point is not defined. This allows deactivating points without the need of delete them for possible future use.

These properties are common for all Intesis KNX series gateways. Although each integration may have specific properties according to the type of signals of the external system.

3.3 KNX Communication Objects

3.3.1 Single DALI device signals

There are up to 94 signals for each DALI device or ballast.

Supported signals vary according to device type, configured through Intesis MAPS.
 Following abbreviations are done in the table:

- FL: Fluorescent light (device type 0)
- EML: Emergency light (device type 1)
- LED: LED module (device type 6)

FLAGS:

If marked with a **black "x"**, it will be enabled by default and couldn't be disabled.
 If marked with **red "x"**, column will be disabled by default but could be enabled by user.
 If marked with **blue "x"**, column will be enabled by default but could be disabled by user.

TOPIC	Ballast / Device Type			NAME	LEN	DATAPOINT TYPE		FLAGS					FUNCTION	
	FL	EML	LED			DPT_NAME	DPT_ID	U	T	Ri	W	R		
COMM ERR	x	x	x	Ballast / Lamp Failure	1 bit	DPT_Alarm	1.005		T				R	0-OK 1-Ballast / Lamp Failure
	x	x	x	Update All ECG Status		DPT_Switch	1.001	U	T	Ri	W	R		0-Update Finished 1-Trigger Update
	x	x	x	Ballast Status	1 byte	Unsigned Value	5.x		T				R	b7-PwrCycle b6-MissShAdd b5-ResetSt b4-FadeRun b3-BallLimErr b2-LampPwrOn b1-LampFail b0-BallFail
	x	x	x	Actual Level	1 byte	DPT_Scaling	5.001		T				R	0 to 100 %

	x	x	x	Device Type	1 byte	Unsigned Value	5.x		T			R	0-Fluorescent 1-Emergency 2 Discharge 3-Halogen 4-Incandescent 5-Digital signal 6-LED 7-Switching 8-Colour Control
	x	x	x	Physical Minimum Level	1 byte	DPT_Scaling	5.001		T			R	0 to 100 %
	x	x	x	Min Level	1 byte	DPT_Scaling	5.001		T			R	0 to 100 %
	x	x	x	Max Level	1 byte	DPT_Scaling	5.001		T			R	0 to 100 %
	x	x	x	Power On Level	1 byte	DPT_Scaling	5.001		T			R	0 to 100 %
	x	x	x	System Failure Level	1 byte	DPT_Scaling	5.001		T			R	0 to 100 %
	x	x	x	Fade Time	1 byte	Unsigned Value	5.x		T			R	0 to 15
	x	x	x	Fade Rate	1 byte	Unsigned Value	5.x		T			R	1 to 15
	x	x	x	Arc Power Level	1 byte	DPT_Scaling	5.001	U		Ri	W	R	0 to 100 %
	x	x	x	Arc Power Off / On	1 bit	DPT_Switch	1.001	U		Ri	W	R	0-Off; 1-100 %
	x	x	x	Step Down / Up	1 bit	DPT_Step	1.007	U		Ri	W	R	0-Step Down, 1-Step Up
	x	x	x	Recall Min Level	1 bit	DPT_Start	1.010	U		Ri	W	R	1-Recall Min Level
	x	x	x	Recall Max Level	1 bit	DPT_Start	1.010	U		Ri	W	R	1-Recall Max Level
	x	x	x	Go to Scene	1 byte	Unsigned Value	5.x	U		Ri	W	R	0 to 15

	x	x	x	Store Current Level as Scene	1 byte	Unsigned Value	5.x	U			Ri	W	R	0 to 15
	x	x	x	Clear/Remove Scene	1 byte	Unsigned Value	5.x	U			Ri	W	R	0 to 15
	x	x	x	Add to DALI Group	1 byte	Unsigned Value	5.x	U			Ri	W	R	0 to 15
	x	x	x	Remove from DALI Group	1 byte	Unsigned Value	5.x	U			Ri	W	R	1 to 15
	x	x	x	Set Fade Time	1 byte	Unsigned Value	5.x	U			Ri	W	R	0 to 100 %
	x	x	x	Set Fade Rate	1 byte	Unsigned Value	5.x	U			Ri	W	R	0 to 100 %
	x	x	x	Set Min Level	1 byte	DPT_Scaling	5.001	U			Ri	W	R	0 to 100 %
	x	x	x	Set Max Level	1 byte	DPT_Scaling	5.001	U			Ri	W	R	0 to 100 %
				Set Power-on Level	1 byte	DPT_Scaling	5.001	U			Ri	W	R	0 to 100 %
	x			Set System-failure Level	1 byte	DPT_Scaling	5.001	U			Ri	W	R	0 to 100 %
		x		Failure Status	1 byte	Unsigned Value	5.x		T				R	b7-FunctFail b6-DurFail b5-DurTestDelay b4-FunctTestDelay b3-EmLampFail b2-BattFail b1-BattDurFail b0-CircFail

	x		Emergency Mode	1 byte	Unsigned Value	5.x	T		R	b7-HardSwOn b6-HardInhibit b5-DurTestProg b4-FunctTestProg b3-ExtdEmMode b2-EmMode b1-NormMode b0-RestMode
	x		Emergency Status	1 byte	Unsigned Value	5.x	T		R	b7-PhysicSel b6-Ident b5-DurTestPend b4-FunctTestPend b3-BattFull b2-DurTestDone b1-FunctTestDone b0-InhibitMode
	x		Emergency Battery Charge	1 byte	DPT_Scaling	5.001	T		R	0 to 100 %
	x		Next Function Test	2 bytes	Signed Value	8.x	T		R	0 to 16384 hours
	x		Next Duration Test	2 bytes	Signed Value	8.x	T		R	0 to 16384 hours
	x		Function Test Interval	1 byte	Unsigned Value	5.x	T		R	0-Disabled, 1 to 255 days
	x		Duration Test Interval	1 byte	Unsigned Value	5.x	T		R	0-Disabled, 1 to 97 weeks
	x		Test Execution Timeout	1 byte	Unsigned Value	5.x	T		R	0 to 255 days
	x		Prolong Time	1 byte	Unsigned Value	5.x	T		R	0 to 127,5 minutes
	x		Duration Test Result	2 bytes	Signed Value	8.x	T		R	0 to 510 minutes
	x		Lamp Total Operation Time	2 bytes	Signed Value	8.x	T		R	0 to 1016 hours

	x		Emergency Level	1 byte	DPT_Scaling	5.001		T			R	0 to 100 %
	x		Emergency Min Level	1 byte	DPT_Scaling	5.001		T			R	0 to 100 %
	x		Emergency Max Level	1 byte	DPT_Scaling	5.001		T			R	0 to 100 %
	x		Rated Duration	2 bytes	Signed Value	8.x		T			R	0 to 510 minutes
	x		Features	1 byte	Unsigned Value	5.x		T			R	b7-RelightRestSup b6-PhysicSelSup b5-HardInSup b4-AdjsEmLvl b3-AutoTestCap b2-SwitchMainCG b1-MainCG b0-IntegralEmCG
	x		Lamp Emergency Time	1 byte	Unsigned Value	5.x		T			R	0 to 254 hours
	x		Rest	1 bit	DPT_Start	1.010	U		Ri	W	R	1-Extinguish Lamp
	x		Inhibit	1 bit	DPT_Start	1.010	U		Ri	W	R	1-Start Inhibit mode
	x		Re-Light/Reset Inhibit	1 bit	DPT_Start	1.010	U		Ri	W	R	1-Cancel Inhibit Mode
	x		Start Function Test	1 bit	DPT_Start	1.010	U		Ri	W	R	1-Start Function Test
	x		Start Duration Test	1 bit	DPT_Start	1.010	U		Ri	W	R	1-Start Duration Test
	x		Stop Test	1 bit	DPT_Start	1.010	U		Ri	W	R	1-Stop Function/Duration Test
	x		Reset Function Test Done Flag	1 bit	DPT_Start	1.010	U		Ri	W	R	1-Reset Function Flag
	x		Reset Duration Test Done Flag	1 bit	DPT_Start	1.010	U		Ri	W	R	1-Reset Duration Flag
	x		Reset Lamp Time	1 bit	DPT_Start	1.010	U		Ri	W	R	1-Lamp Emergency Time Reset

	x		Store Test Execution Timeout	1 byte	Unsigned Value	5.x	U			Ri	W	R	0 to 255 days
		x	Store Prolong Time	1 byte	Unsigned Value	5.x	U			Ri	W	R	0 to 127,5 minutes
		x	Store Function Test Interval	1 byte	Unsigned Value	5.x	U			Ri	W	R	0-Disabled 1 to 255 days
		x	Store Duration Test Interval	1 byte	Unsigned Value	5.x	U			Ri	W	R	0-Disabled, 1 to 97 weeks
		x	Store Emergency Level	1 byte	Unsigned Value	5.x	U			Ri	W	R	0 to 100 %
			x	Failure Status	1 byte	Unsigned Value	5.x		T			R	b7-RefMeasurFail b6-ThermLightLvl b5-ThermShut b4-CurrProtAct b3-LoadInc b2-LoadDec b1-OpenC b0-ShortC
			x	Gear Type	1 byte	Unsigned Value	5.x		T			R	b3-dcSuppPoss b2-acSuppPoss b1-LEDModInt b0-LEDPowerSInt
			x	Dimming Curve	1 bit	Binary Value	1.x		T			R	0-Standard Logarithmic Dim Curve 1-Linear Dim Curve
			x	Possible Operating Modes	1 byte	Unsigned Value	5.x		T			R	b3-HighCurrPulMod b2-OutCurrContr b1-AMModePoss b0-PWMModePoss

		x	Features	1 byte	Unsigned Value	5.x	T			R	b7-PhysicSelSupp b6-LightLvlRedReq b5-ThermShutReq b4-CurrProtActReq b3-LoadIncReq b2-LoadDecReq b1-OpenCQ b0-ShortCQ
		x	Reference Running	1 bit	DPT_Boot	1.002	T			R	0-No, 1-Yes
		x	Current Protector	1 bit	DPT_Enable	1.003	T			R	0-Disabled, 1-Enabled
		x	Operating Mode	1 byte	Unsigned Value	5.x	T			R	b4-NonLogDimCurveAct b3-HighCurrPulModeAct b2-OutCurrContr b1-AMModeAct b0-PWMModeAct
		x	Fast Fade Time	1 byte	Unsigned Value	5.x	T			R	0 to 27
		x	Min Fast Fade Time	1 byte	Unsigned Value	5.x	T			R	0 to 27
		x	Reference System Power	1 bit	DPT_Start	1.010	U		Ri	W R	1-Trigger DALI Power Referencing
		x	Enable/Disable Current Protector	1 bit	DPT_Enable	1.003	U		Ri	W R	0-Disable 1-Enable
		x	Select Dimming Curve	1 bit	Binary Value	1.x	U		Ri	W R	0-Standard Logarithmic Dim Curve 1-Linear Dim Curve
		x	Store Fast Fade Time	1 byte	Unsigned Value	5.x	U		Ri	W R	0 to 27

3.3.2 DALI groups' signals

DALI supports group addressing of ballasts. Up to 16 groups can be defined in a DALI channel. In Intesis, there are up to 16 signals for each DALI group.

Supported signals vary according to device type, configured through Intesis MAPS.
Following abbreviations are done in the table:

- FL: Fluorescent light (device type 0)
- EML: Emergency light (device type 1)
- LED: LED module (device type 6)

FLAGS:
If marked with a **black "x"** will be enabled by default and couldn't be disabled.
If marked with **red "x"**, column will be disabled by default but could be enabled by user.
If marked with **blue "x"**, column will be enabled by default but could be disabled by user.

TOPIC	Ballast / Device Type			NAME	LEN	DATAPOINT TYPE		FLAGS					FUNCTION
	FL	EML	LED			DPT_NAME	DPT_ID	U	T	Ri	W	R	
COMM ERR	x	x	x	Arc Power Level	1 bit	DPT_Alarm	1.005	U		Ri	W	R	0 to 100 %
	x	x	x	Arc Power Off / On	1 bit	DPT_Switch	1.001	U		Ri	W	R	0-Off; 1-100 %
	x	x	x	Step Down / Up	1 bit	DPT_Step	1.007	U		Ri	W	R	0-Step Down 1-Step Up
	x	x	x	Recall Min Level	1 bit	DPT_Start	1.010	U		Ri	W	R	1-Recall Min Level
	x	x	x	Recall Max Level	1 bit	DPT_Start	1.010	U		Ri	W	R	1-Recall Max Level
	x	x	x	Go to Scene	1 byte	Unsigned Value	5.x	U		Ri	W	R	0 to 15
	x	x	x	Store Current Level as Scene	1 byte	Unsigned Value	5.x	U		Ri	W	R	0 to 15
	x	x	x	Clear/Remove Scene	1 byte	Unsigned Value	5.x	U		Ri	W	R	0 to 15
	x	x	x	Set Fade Time	1 byte	Unsigned Value	5.x	U		Ri	W	R	0 to 15
	x	x	x	Set Fade Rate	1 byte	Unsigned Value	5.x	U		Ri	W	R	1 to 15

	x	x	x	Set Min Level	1 byte	DPT_Scaling	5.001	U			Ri	W	R	0 to 100 %
	x	x	x	Set Max Level	1 byte	DPT_Scaling	5.001	U			Ri	W	R	0 to 100 %
	x	x	x	Set Power-on Level	1 byte	DPT_Scaling	5.001	U			Ri	W	R	0 to 100 %
	x	x	x	Set System-failure Level	1 byte	DPT_Scaling	5.001	U			Ri	W	R	0 to 100 %

3.3.3 Broadcast signals

Broadcast signals allow to control all ballasts in the same line from an individual signal.

Supported signals vary according to device type, configured through Intesis MAPS.
Following abbreviations are done in the table:

- FL: Fluorescent light (device type 0)
- EML: Emergency light (device type 1)
- LED: LED module (device type 6)

FLAGS:
If marked with a **black "x"** will be enabled by default and couldn't be disabled.
If marked with **red "x"**, column will be disabled by default but could be enabled by user.
If marked with **blue "x"**, column will be enabled by default but could be disabled by user.

TOPIC	Ballast / Device Type			NAME	LEN	DATAPOINT TYPE		FLAGS					FUNCTION
	FL	EML	LED			DPT_NAME	DPT_ID	U	T	Ri	W	R	
COMM ERR	x	x	x	Arc Power Level	1 bit	DPT_Alarm	1.005	U		Ri	W	R	0 to 100 %
	x	x	x	Arc Power Off / On	1 bit	DPT_Switch	1.001	U		Ri	W	R	0-Off; 1-100 %
	x	x	x	Step Down / Up	1 bit	DPT_Step	1.007	U		Ri	W	R	0-Step Down 1-Step Up
	x	x	x	Recall Min Level	1 bit	DPT_Start	1.010	U		Ri	W	R	1-Recall Min Level
	x	x	x	Recall Max Level	1 bit	DPT_Start	1.010	U		Ri	W	R	1-Recall Max Level
	x	x	x	Go to Scene	1 byte	Unsigned Value	5.x	U		Ri	W	R	0 to 15
	x	x	x	Store Current Level as Scene	1 byte	Unsigned Value	5.x	U		Ri	W	R	0 to 15
	x	x	x	Clear/Remove Scene	1 byte	Unsigned Value	5.x	U		Ri	W	R	0 to 15
	x	x	x	Set Fade Time	1 byte	Unsigned Value	5.x	U		Ri	W	R	0 to 15
	x	x	x	Set Fade Rate	1 byte	Unsigned Value	5.x	U		Ri	W	R	1 to 15

	x	x	x	Set Min Level	1 byte	DPT_Scaling	5.001	U			Ri	W	R	0 to 100 %
	x	x	x	Set Max Level	1 byte	DPT_Scaling	5.001	U			Ri	W	R	0 to 100 %
	x	x	x	Set Power-on Level	1 byte	DPT_Scaling	5.001	U			Ri	W	R	0 to 100 %
	x	x	x	Set System-failure Level	1 byte	DPT_Scaling	5.001	U			Ri	W	R	0 to 100 %

3.3.4 Input Devices signals

Input Devices signals allow to monitor all input devices in the same line from an individual signal.

FLAGS:
 If marked with a **black "x"** will be enabled by default and couldn't be disabled.
 If marked with **red "x"**, column will be disabled by default but could be enabled by user.
 If marked with **blue "x"**, column will be enabled by default but could be disabled by user.

NAME	LEN	DATAPOINT TYPE		FLAGS					FUNCTION	
		DPT_NAME	DPT_ID	U	T	Ri	W	R		
Occupancy InputValue	1 byte	Unsigned Value	5.x		T				R	0-Vacant + No Mov 1-Vacant + Mov 2-Occupied + No Mov 3-Occupied + Mov
Light InputValue	2 bytes	Unsigned Value	7.x		T				R	

4 Connections

Find below information regarding the Intesis connections available.

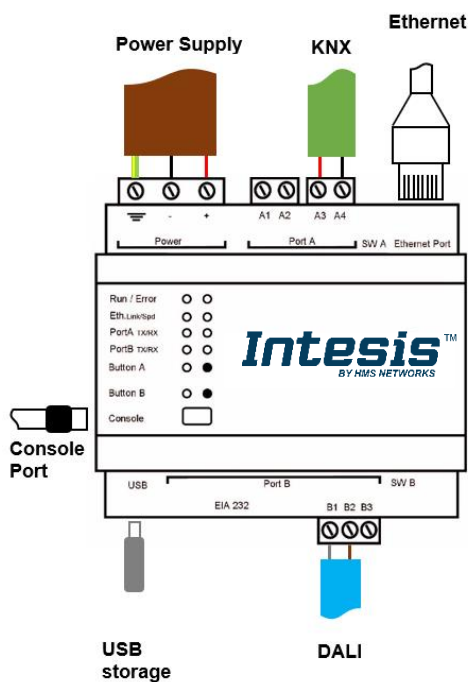

Power Supply

Must use NEC Class 2 or Limited Power Source (LPS) and SELV rated power supply. Respect polarity applied of terminals (+) and (-). Be sure the voltage applied is within the range admitted (check section 7). The power supply can be connected to earth but only through the negative terminal, never through the positive terminal.

If using DC power supply:

Respect polarity applied of terminals (+) and (-). Be sure the voltage applied is within the range admitted (check table below). The power supply can be connected to earth but only through the negative terminal, never through the positive terminal.

Ethernet

Connect the cable coming from the IP network to the connector ETH of the gateway. Use an Ethernet CAT5 cable. If communicating through the LAN of the building, contact the network administrator and make sure traffic on the port used is allowed through all the LAN path (check the gateway user manual for more information). Default IP is 192.168.100.246. DHCP is enabled by default.

PortA / KNX

Connect the KNX TP1 bus to connectors A3 (+) and A4 (-) of gateway's PortA. Respect the polarity.

PortB / DALI

Connect the DALI bus to connectors A4 (+), A3 (-) of gateway's PortA. Intesis provides 16VDC (+/-2%) DALI voltage to the bus.

Console Port

Connect a mini-type B USB cable from your computer to the gateway to allow communication between the Configuration Software and the gateway. Remember that Ethernet connection is also allowed.

USB

Connect a USB storage device (not a HDD) if required. Check port characteristics on section 7.

Ensure proper space for all connectors when mounted (see section 8).

4.1 Powering the device

A power supply working with any of the voltage range allowed is needed (check section 7). Once connected the RUN led (Figure above) will turn on.

WARNING! In order to avoid earth loops that can damage the gateway and/or any other equipment connected to it, we strongly recommend the use of DC power supplies, floating or with the negative terminal connected to earth. **Never use a DC power supply with the positive terminal connected to earth.**

4.2 Connection to DALI channel.

Connect + and – terminals of the DALI bus of your DALI channel to Intesis' DALI port. Bus has polarity, but most DALI ballasts are polarity insensitive.

Having your DALI channel powered up, you can perform a quick DALI connectivity test by pressing Port B button:

- When pressing Port B button, a broadcast command that will toggle the ballasts between 100% and 0% level will be sent.
- After 30s timeout of not pressing the button, ballasts will return back to its original level.

DALI commands coming from KNX will continue to be executed while doing this test.

4.3 Connection to KNX

Connect the communication cable coming from the KNX bus to the PortA (Figure above) of Intesis.

In case there is no response from the KNX installation or KNX devices to the telegrams sent by the Intesis, check that they are operative and reachable from the KNX installation used by Intesis.

Check as well if there is a line coupler that it is not filtering the telegrams from/to the Intesis.

4.4 Connection to PC (Configuration tool)

This action allows the user to have access to configuration and monitoring of the device. Two methods to connect to the PC can be used:

- **Ethernet:** Using the Ethernet port of the Intesis.
- **USB cable:** To connect the device to the PC, the USB cable supplied should be plugged to the USB Console port.

5 Status LEDs and push buttons

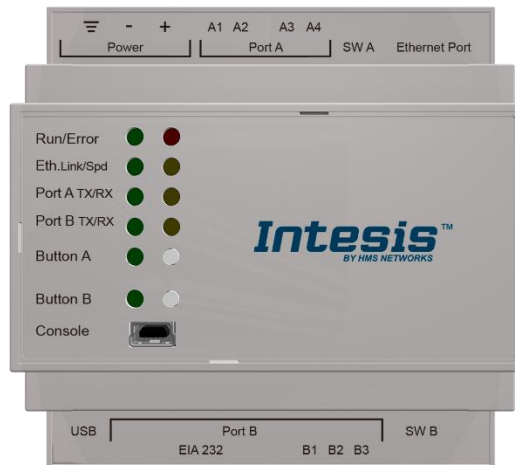

LED	Colour	Indication
Run	Off	No power
	Green	Device powered and working.
Error	Off	No error
	Red	Error
Port A (Tx/Rx) – KNX	Off	There is no activity on this port.
	Tx - Blinking green	Every data packet sent to UFO device it blinks
	Rx – Blinking yellow	Every data packet received from UFO device it blinks
Port B (Tx/Rx) – DALI #0	Off	There is no activity on this port.
	Tx - Blinking green	Every data packet sent to UFO device it blinks
	Rx – Blinking yellow	Every data packet received from UFO device it blinks
Button A – KNX	Off / Red	On if the IBOX is in programming mode
Button B – DALI #0	Off / Red	Indicates status of last command sent from the button (On-RECALL_MAX_LEVEL, Off-OFF) After 30 secs of not pushing the button, the LED turns OFF and next time the button is pushed it will begin with RECALL_MAX_LEVEL

Push button	Functionality
Button A – KNX	Switches the IBOX between normal mode/programming mode
Button B – DALI #0	Sends to broadcast, alternatively: RECALL_MAX_LEVEL, OFF

6 Set-up process and troubleshooting

6.1 Pre-requisites

It is necessary to have the KNX system (specific KNX power supply and bus) operative and properly connected to the corresponding port of the gateway. It is also required to have a DALI installation connected to the gateway, in its respective DALI port.

Connectors, connection cables, PC for the usage of the Configuration Tool and other auxiliary material, if needed, are not supplied by Intesis for this standard integration.

Items supplied with this product for this integration are:

- Intesis gateway.
- Link to download the configuration tool.
- USB Console cable to communicate with Intesis.
- Product documentation.

6.2 Intesis MAPS. Configuration & monitoring tool for Intesis

6.2.1 Introduction

Intesis MAPS is a Windows® compatible software developed specifically to monitor and configure Intesis new generation gateways.

The installation procedure and main functions are explained in the *Intesis MAPS User Manual*. This document can be downloaded from the link indicated in the installation sheet supplied with the Intesis device or in the product website at www.intesis.com

In this section, only the specific case of DALI to KNX will be covered.

Please check the Intesis MAPS user manual for specific information about the different parameters and how to configure them.

6.2.2 Connection

To configure the Intesis connection parameters press on the **Connection** button in the *menu bar*.

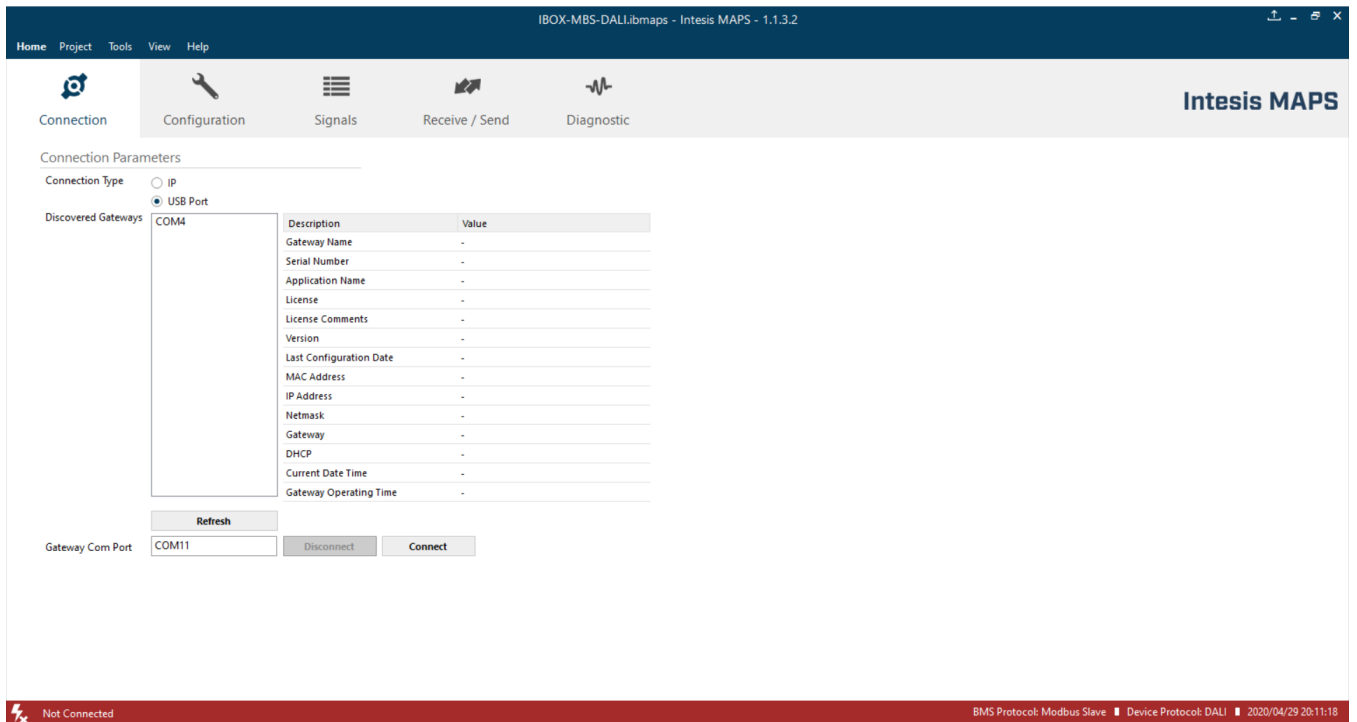

Figure 6.1 MAPS connection

6.2.3 Configuration tab

Select the **Configuration** tab to configure the connection parameters. Three subsets of information are shown in this window: General (Gateway general parameters), KNX (KNX interface configuration) and DALI (DALI channel and DALI devices configuration).

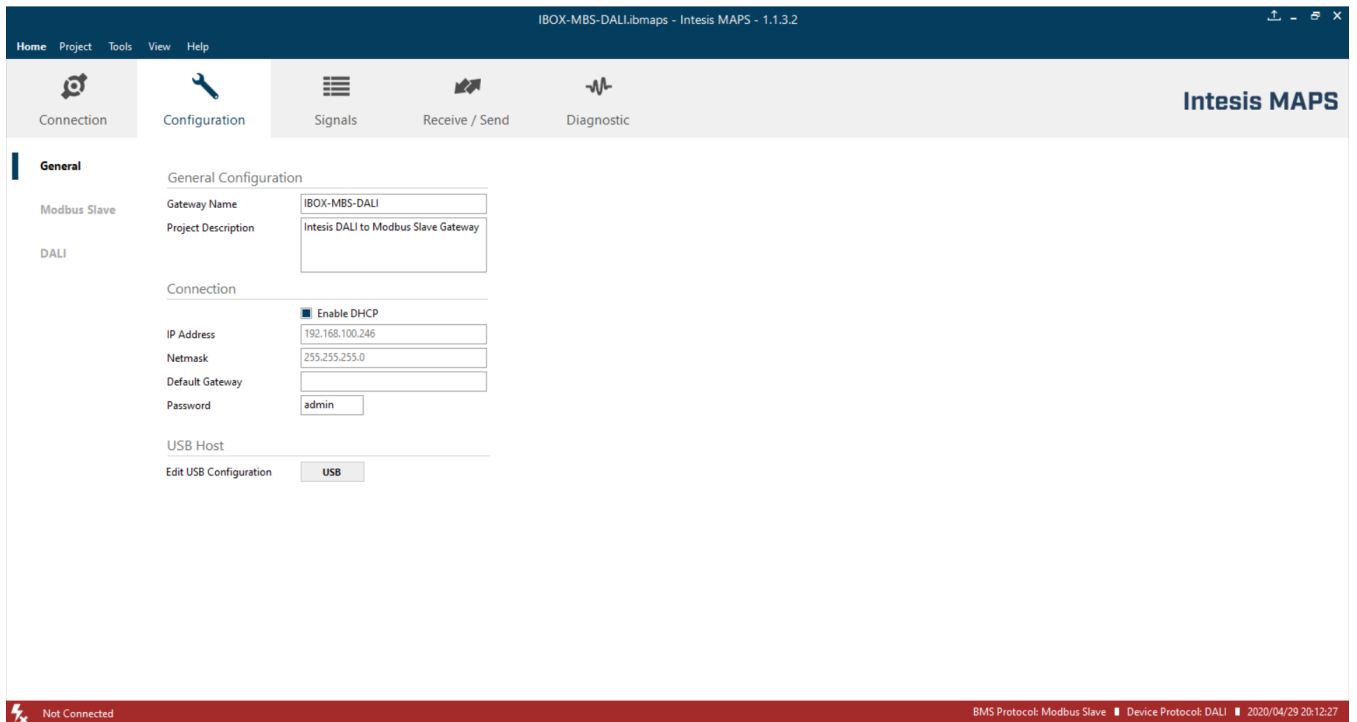

Figure 6.2 Intesis MAPS configuration tab

General, KNX and DALI tabs are explained in Intesis MAPS user manual for Intesis KNX Server Series.

6.2.4 Signals

All available registers, its corresponding description and other main parameters are listed in the signals tab.

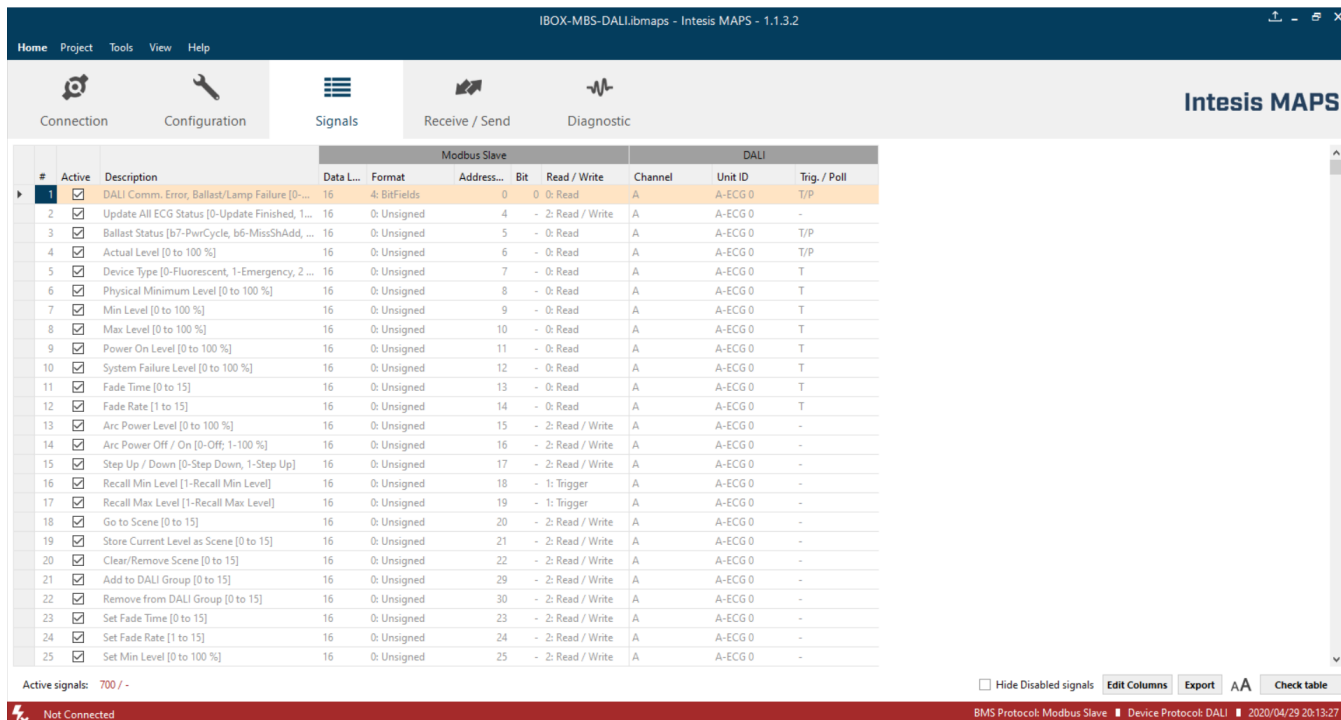

Figure 6.3 Intesis MAPS Signals tab

6.2.5 Sending the configuration to Intesis

When the configuration is finished, follow the steps to program the gateway.

- 1.- Click on **Save** button to save the project to the project folder on your hard disk (more information in Intesis MAPS User Manual).
- 2.- You will be prompted to generate the configuration file to be sent to the gateway.
 - a.- If **Yes** is selected, the file containing the configuration for the gateway will be generated and saved also into the project folder.
 - b.- If **NO** is selected, remember that the binary file with the project needs to be generated before the Intesis starts to work as expected.
- 3.- Press the **Send File** button to send the binary file to the Intesis device. The process of file transmission can be monitored in the Intesis Communication Console window. Intesis will reboot automatically once the new configuration is loaded.

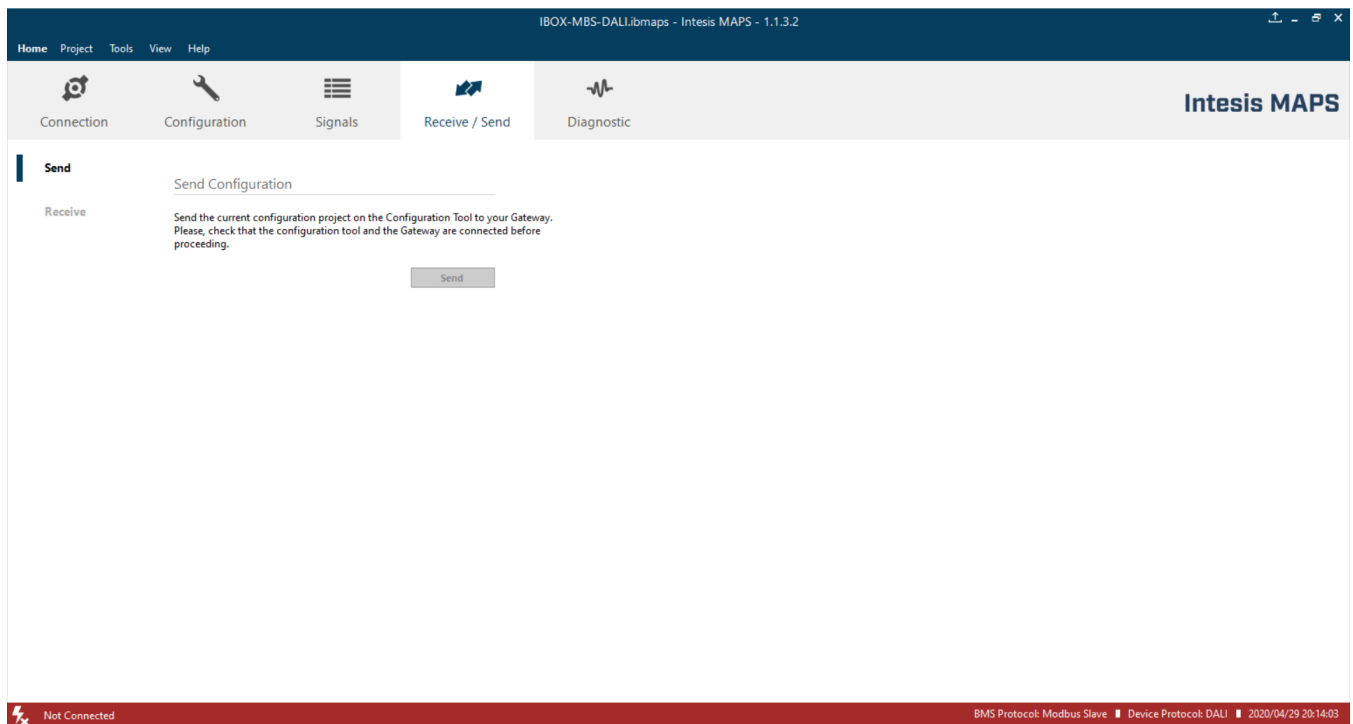

Figure 6.4 Intesis MAPS Receive/Send tab

After any configuration change, do not forget to send the configuration file to the Intesis using the button “Send”.

6.2.6 Diagnostic

To help integrators in the commissioning tasks and troubleshooting, the Configuration Tool offers some specific tools and viewers.

In order to start using the diagnostic tools, the connection with the Gateway must be established.

The Diagnostic section is composed by two main parts: Tools and Viewers.

- **Tools**
Use the tools section to check the current hardware status of the box, log communications into compressed files to be sent to the support, change the Diagnostic panels' view or send commands to the gateway.
- **Viewers**
In order to check the current status, viewer for the Internal and External protocols are available. It is also available a generic Console viewer for general information about communications and the gateway status. Finally, a Signals Viewer to simulate the BMS behavior or to check the current values in the system.

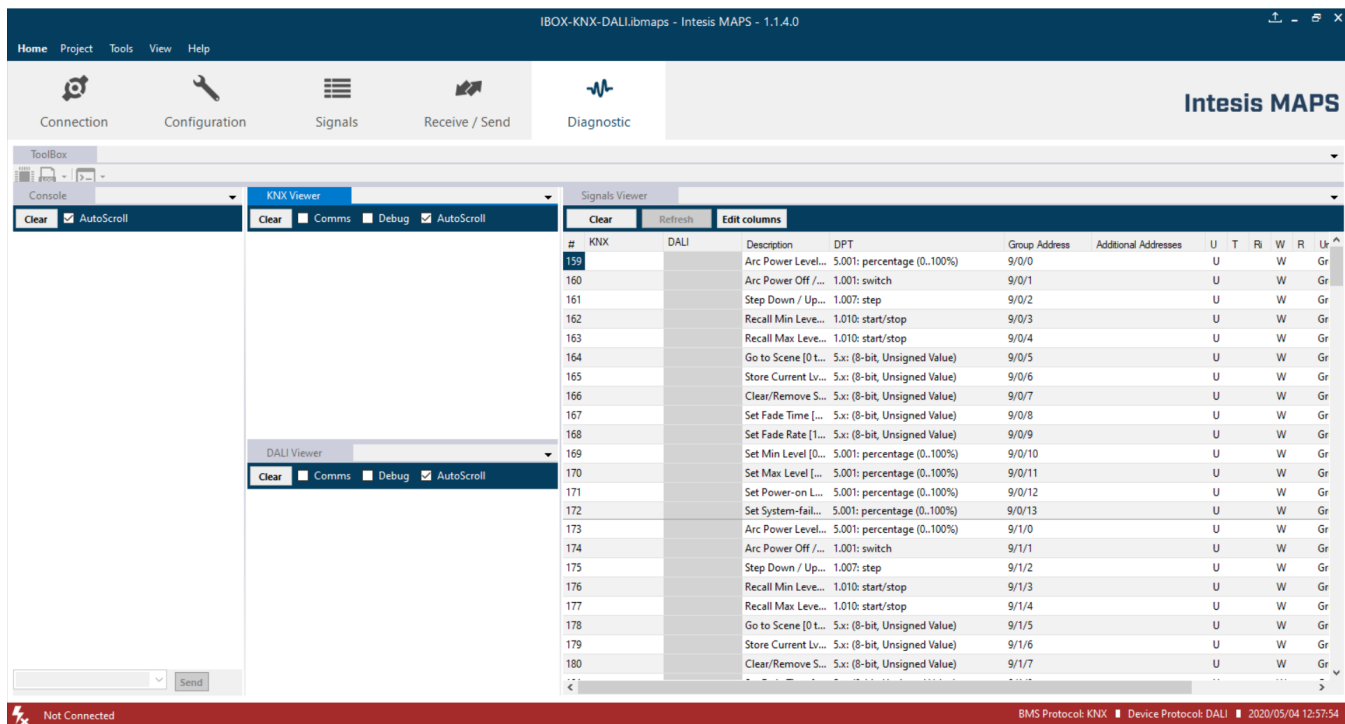

Figure 6.5 Diagnostic

More information about the Diagnostic section can be found in Intesis MAPS user manual for Intesis KNX Series.

6.3 Set-up procedure

1. Install Intesis MAPS on your laptop, use the setup program supplied for this and follow the instructions given by the Installation wizard.
2. Install Intesis in the desired installation site. Installation can be on DIN rail or on a stable not vibrating surface (DIN rail mounted inside a metallic industrial cabinet connected to ground is recommended).
3. Connect the communication cable coming from the KNX bus to the port marked as Port A of Intesis (More details in section 4).
4. Connect the communication cable coming from DALI network to the port marked as Port B of Intesis (More details in section 4).
5. Power up Intesis. The supply voltage is 24 Vdc. Take care of the polarity of the supply voltage applied.

WARNING! In order to avoid earth loops that can damage Intesis and/or any other equipment connected to it, we strongly recommend:

- The use of DC power supplies, floating or with the negative terminal connected to earth. **Never use a DC power supply with the positive terminal connected to earth.**
6. If you want to connect using IP, connect the Ethernet cable from the laptop PC to the port marked as Ethernet of Intesis (More details in section 4).

If you want to connect using USB, connect the USB cable from the laptop PC to the port marked as Console of Intesis (More details in section 4).

7. Open Intesis MAPS, create a new project for KNX and select the INKNXDAL---0200-Template project.
8. Modify the configuration as desired, save it and download the configuration file to Intesis as explained in section 6.2.5 .
9. Visit the Diagnostic section, enable COMMS and check that there is communication activity, some TX frames and some other RX frames. This means that the communication with the Centralized Controller and KNX installation is OK. In case there is no communication activity between Intesis and the Centralized Controller and/or KNX devices, check that those are operative: check the communication cable used to connect all devices, the physical address, the group addresses and any other communication parameter.

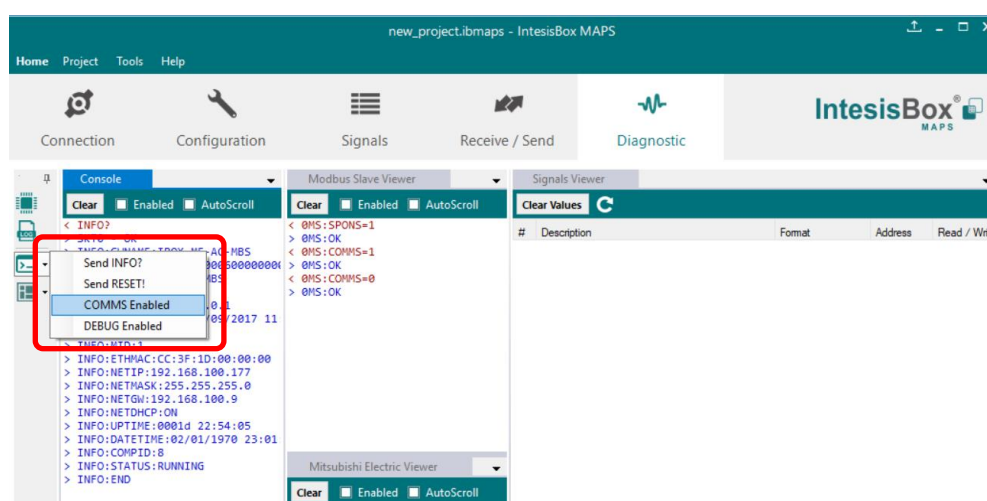
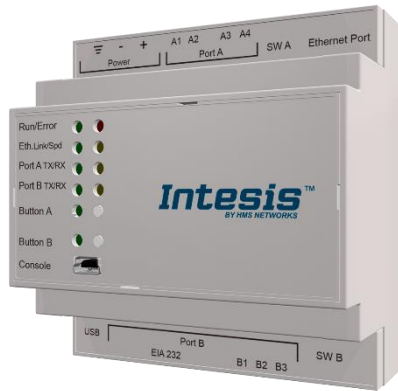

Figure 6.6 Enable COMMS

7 Electrical & Mechanical Features



Enclosure	Plastic, type PC (UL 94 V-0) Net dimensions (d×w×h): 90x88x56 mm Recommended space for installation (d×w×h): 130x100x100mm Color: Light Grey. RAL 7035	Battery	Size: Coin 20mm x 3.2mm Capacity: 3V / 225mAh Type: Manganese Dioxide Lithium
Mounting	Wall. DIN rail EN60715 TH35.	Console Port	Mini Type-B USB 2.0 compliant 1500VDC isolation
Terminal Wiring (for power supply and low-voltage signals)	Per terminal: solid wires or stranded wires (twisted or with ferrule) 1 core: 0.5mm ² ... 2.5mm ² 2 cores: 0.5mm ² ... 1.5mm ² 3 cores: not permitted If cables are more than 3.05 meters long, Class 2 cable is required.	USB port	Type-A USB 2.0 compliant Only for USB flash storage device (<i>USB pen drive</i>) Power consumption limited to 150mA (<i>HDD connection not allowed</i>)
Power	1 x Plug-in screw terminal block (3 poles) Positive, Negative, Earth 24VDC	Push Button	Button A: Check the user manual Button B: Check the user manual
Ethernet	1 x Ethernet 10/100 Mbps RJ45 2 x Ethernet LED: port link and activity	Operation Temperature	0°C to +50°C
Port A	1 x KNX TP-1 Plug-in screw terminal block orange (2 poles) 2500VDC isolation from other ports KNX power consumption: 5mA Voltage rating: 29VDC 1 x Plug-in screw terminal block green (2 poles) Reserved for future use	Operational Humidity	5 to 95%, no condensation
Switch A (SWA)	1 x DIP-Switch for serial EIA485 configuration: Reserved for future use	Protection	IP20 (IEC60529)
PORT B	1 x Serial EIA232 (SUB-D9 male connector) Reserved for future use 1 x Serial EIA485 Plug-in screw terminal block (3 poles) B1, B2 1500VDC isolation from other ports DALI guaranteed power: 235mA Voltage rating: 16VDC (<i>except PORT B: EIA232</i>)	LED Indicators	10 x On board LED indicators 1 x Error LED 1 x Power LED 2 x Ethernet Link/Speed 2 x Port A TX/RX 2 x Port B TX/RX 1 x Button A indicator 1 x Button B indicator
Switch B (SWB)	1 x DIP-Switch for serial EIA485 configuration: Reserved for future use		

8 Dimensions

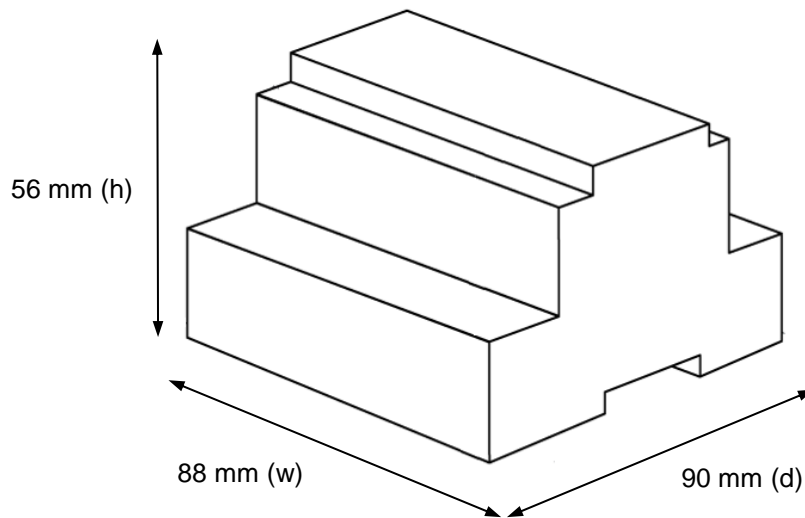

Recommended available space for its installation into a cabinet (wall or DIN rail mounting), with space enough for external connections

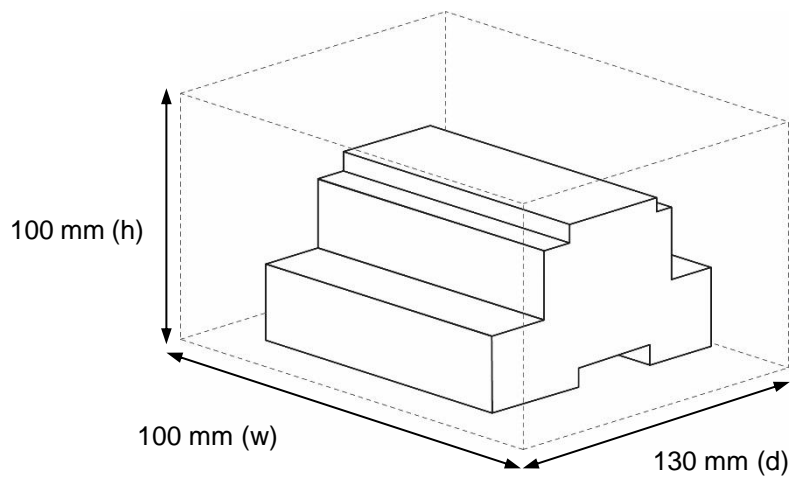

Annex A – Quick setup and commissioning of a DALI network

This section provides a brief summary on commissioning a DALI channel using MAPS software tool. The process of commissioning involves:

- Scanning the existing ballasts (ECGs) and sensors (Input Devices) in the DALI network
- Identifying their physical location
- Obtaining or setting up device short addresses
- Obtaining or editing devices configuration parameters (preset levels, scenes, groups addressing...)

In that process, using MAPS, two workflows are possible for the commissioning:

1. “Device declaration first”: First declaring or instantiating in MAPS the envisaged (planned) devices in the installation, setting up values for all their configuration parameters, and then scanning the network for existing devices. Process finalizes with assignation and download of planned configuration parameters (including short addresses) with existing devices in the installation.
2. “Existing devices scan first”: Alternatively, and more common, it is possible to scan first the DALI network for existing devices, obtain their existing configuration (which will be default/factory if the devices are new), then change these parameters to match the desired ones (short address, preset levels, scenes...) and load the devices with the new configuration.

Typically, “Existing devices scan first” method will be used when all commissioning is done in the installation itself, as it starts with a DALI bus scan. “Device declaration first” allows to do some work in advance, defining the configuration parameters for the ballasts and sensors before accessing the actual installation. It is possible to understand the “Device declaration first” as a previous step that can (but not must) be done before effectively scanning the network for devices (“Existing devices scan first”), in order to advance configuration work (definition of preset levels, DALI groups, scene values, ...).

It is perfectly possible to mix the two methods. This is, configure a certain number of ballasts declaring them in MAPS (“Device declaration first”), and once in the installation, assign their parameters to existing ballasts and sensors. Whenever more devices are installed, they can be added by scanning them in the network (“Existing devices scan first”) and changing its configuration parameters to match the desired ones (without previous instantiation of them in MAPS).

8.1 Create project

You will need to create a new project, to do so, select 'Create New project' in MAPS start screen, and choose the appropriate template according to your device model (1 or 2 DALI channels / 64 or 128 max DALI devices):

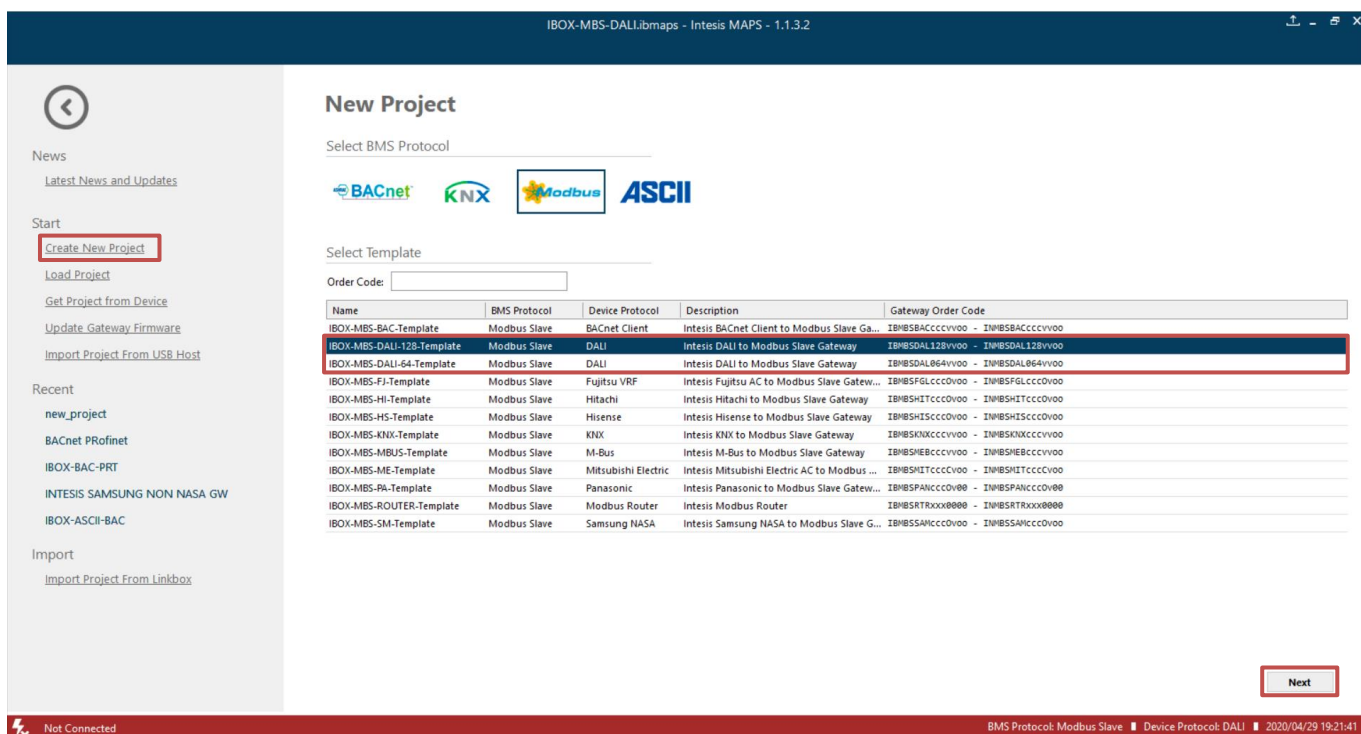

Figure A.1 New project creation

8.2 Device declaration in project

Once new project has been created, DALI devices can be added to the configured project, without the need of scanning them in bus.

As mentioned above, this allows defining its configuration parameters (preset values, groups, scenes, ...) before having actual access to the installation.

To do so, go to the 'Configuration' tab of MAPS, and select the 'DALI' section.

In it, choose the channel where you want to instantiate the devices (A or B are possible in case of having the product version supporting 2 DALI channels), then select ECG node to add new ballasts, or select Sensors node to add new sensors.

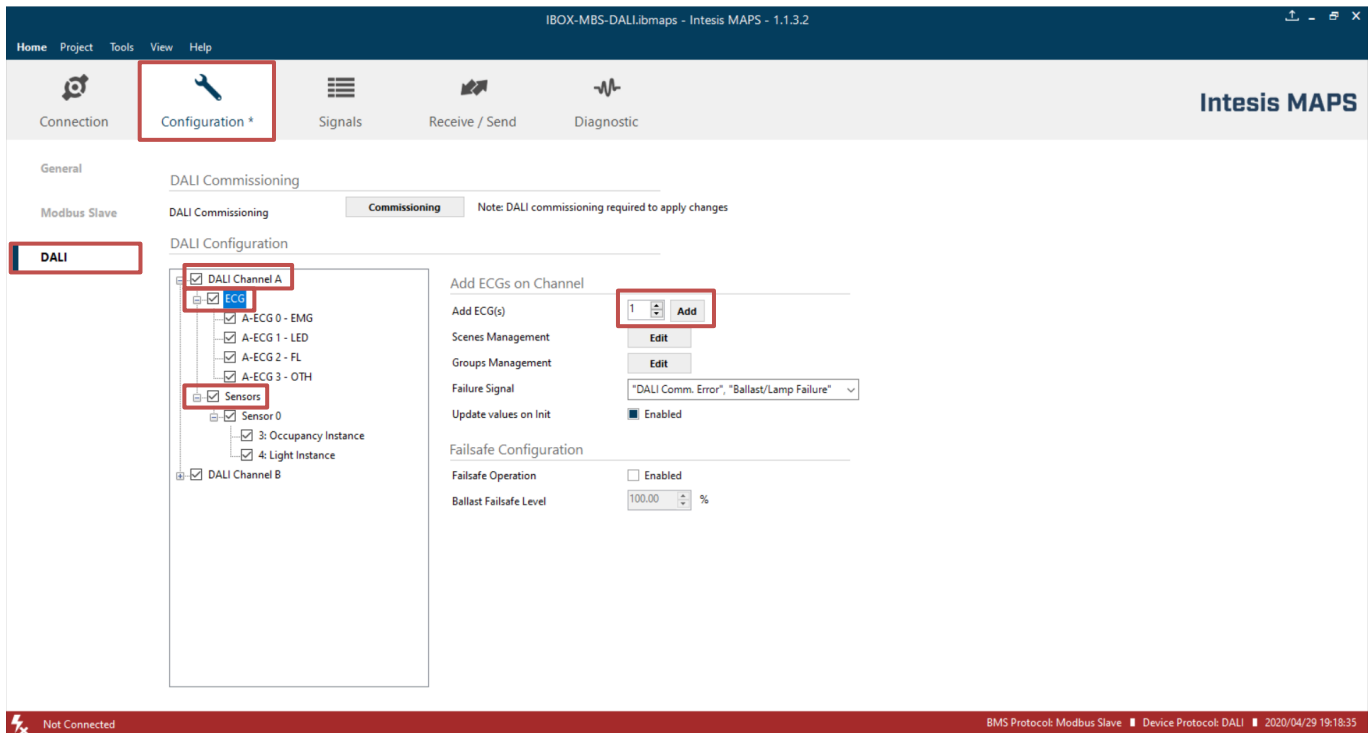

Figure A.2 Add new devices

With suitable DALI channel selected, enter in 'Add ECG(s)'/ 'Add Sensor(s)' field the number of ECGs/Sensors to instantiate, and click button Add.

Number of desired devices will appear:

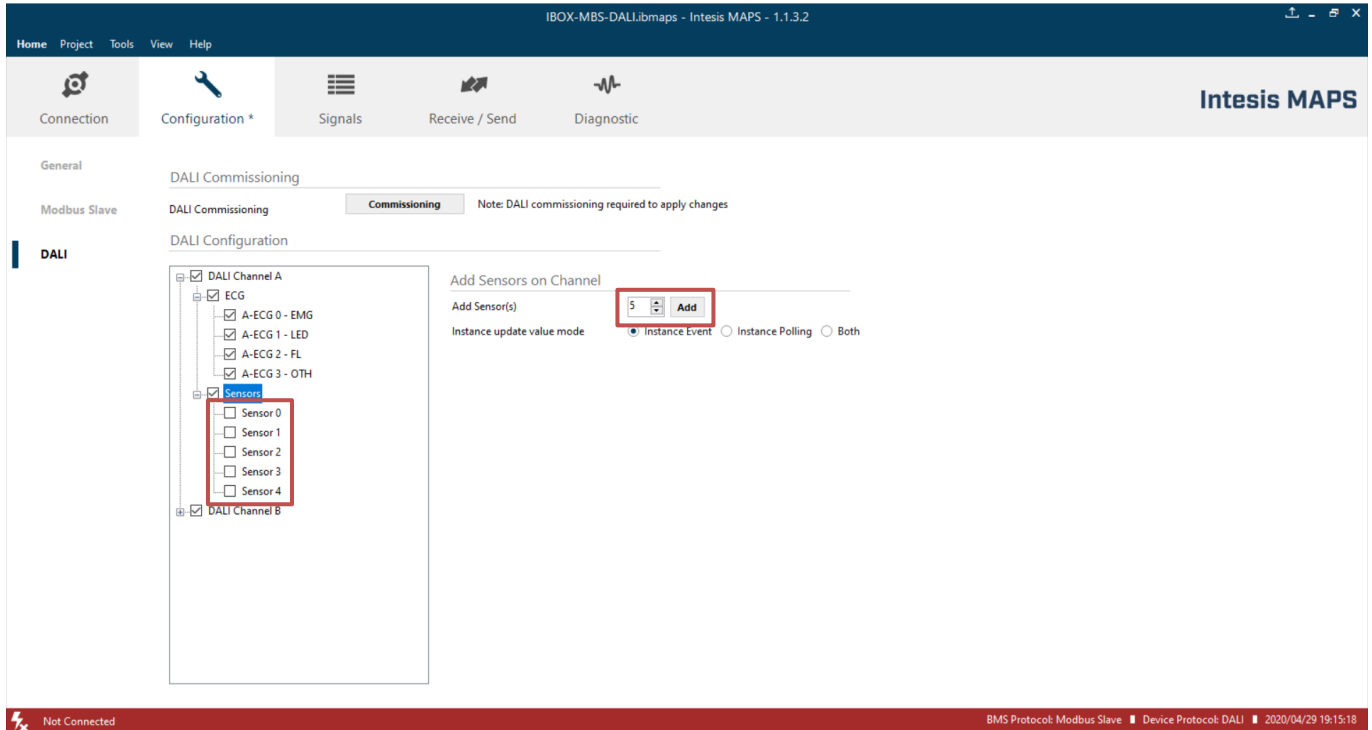

Figure A.3 Adding new sensors

If too many devices have been instantiated, they can be deleted by selecting them, and pressing button 'Delete ECG(s)'. Multiple selection is also possible.

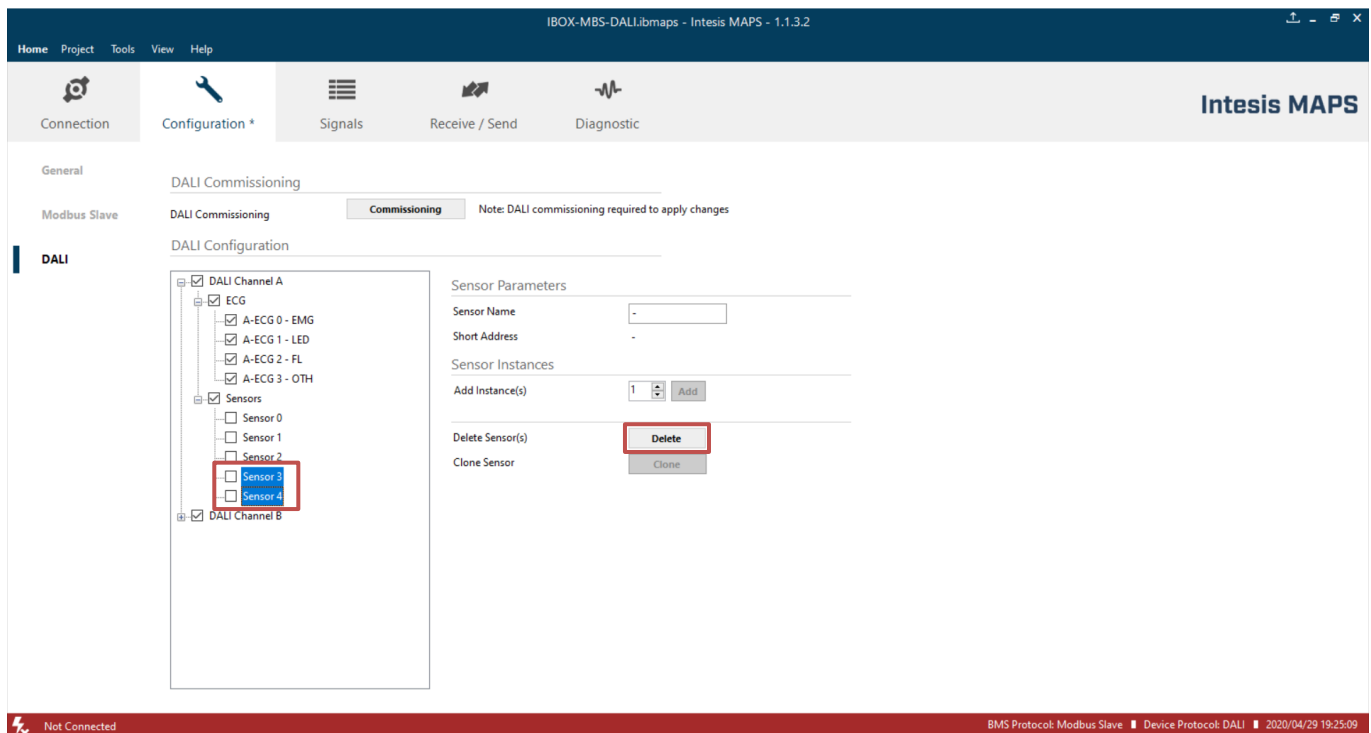

Figure A.4 Deleting devices

Finally, for all devices in configuration, you will need to define:

- For ballasts:
 - **ECG Name** (optional): Name to ease its identification in the network
 - **Device type**: It's important that this field is suitably chosen and according to existing ballast in the network (device type 0: Fluorescent Light, device type 1: Emergency Light, device type 6: LED module or 'Other' (default) if none of the above matches the device type).
 - **Commitable ECG Parameters**: This includes all preset values for the ballasts (min level, max level, power on level, etc), as well as group assignation and scene configuration.
- For Input Devices (Sensors):
 - **Sensor Name** (optional): Name to ease its identification in the network.
 - **Add required Instances**: Each input device can include up to 32 different instance types (i.e. instance type 4: Light sensor; instance type 3: Motion sensor; and so on...)

8.3 Scan and commissioning of devices

First you need to get MAPS connected to the Intesis device. To do so, go to 'Connection' tab of MAPS. There, select appropriate connection mode (IP or USB). Select your device from the list of scanned devices (IP) or suitable COM port (USB).

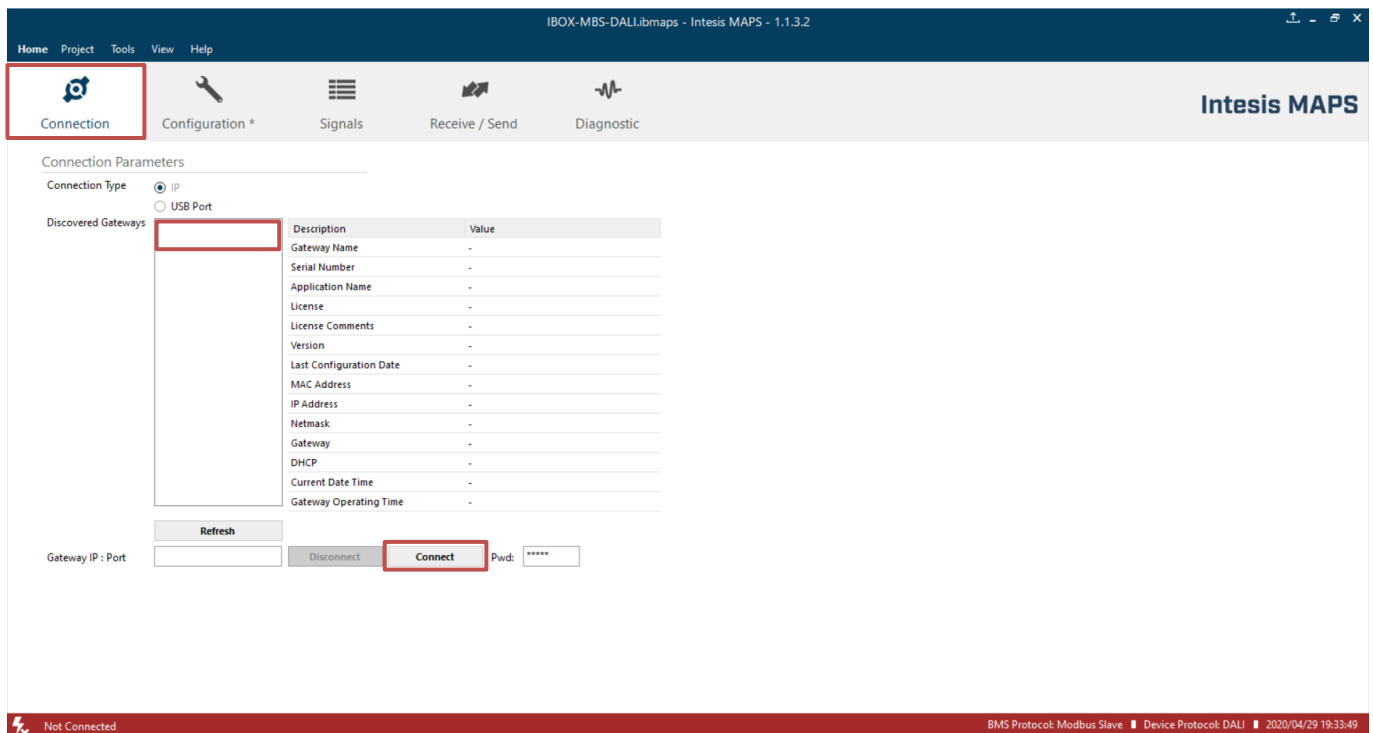

Figure A.5 Connecting MAPS to the Intesis

Finally, click on button 'Connect' in order to establish connection. Bar at the bottom in MAPS main window will become green, switching from 'Not Connected' to 'Connected'.

Now go back to 'Configuration' tab of MAPS, and click on button 'Commissioning':

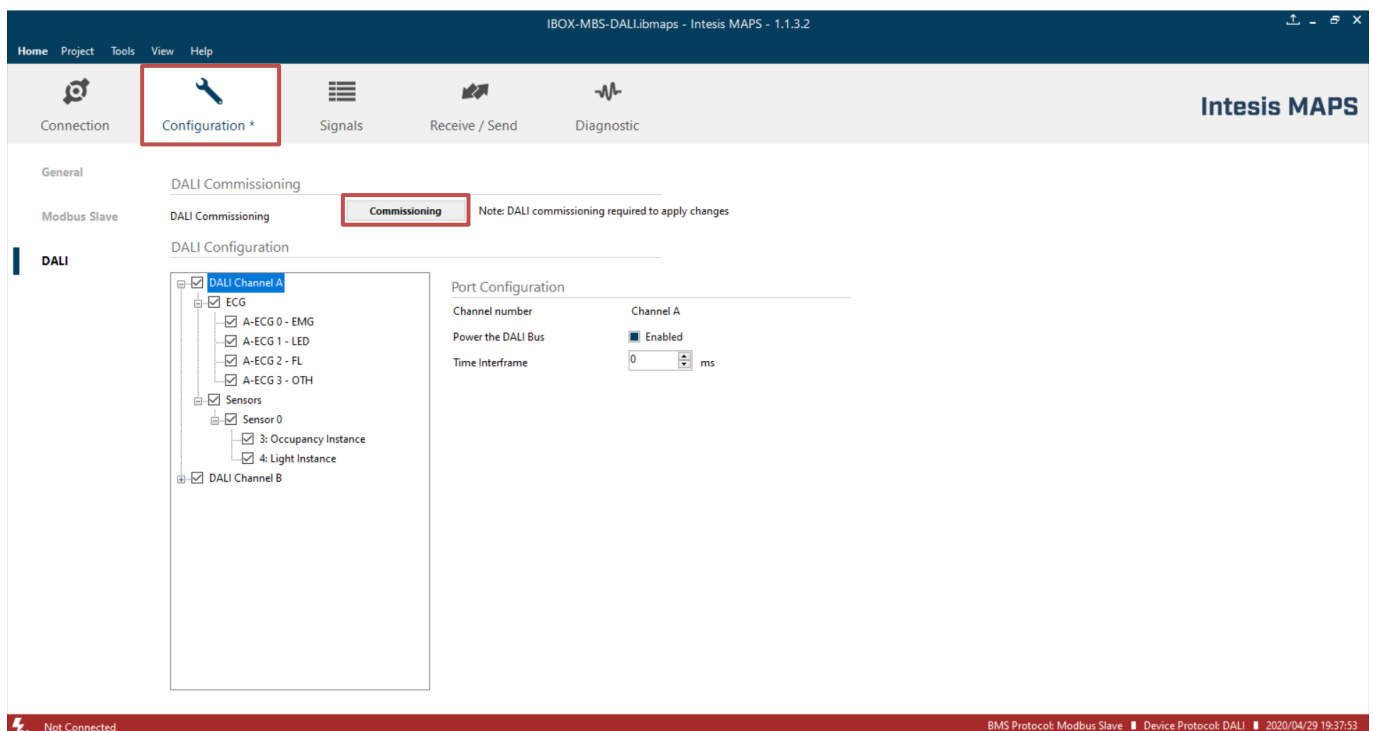

Figure A.6 DALI commissioning button

Commissioning window will appear:

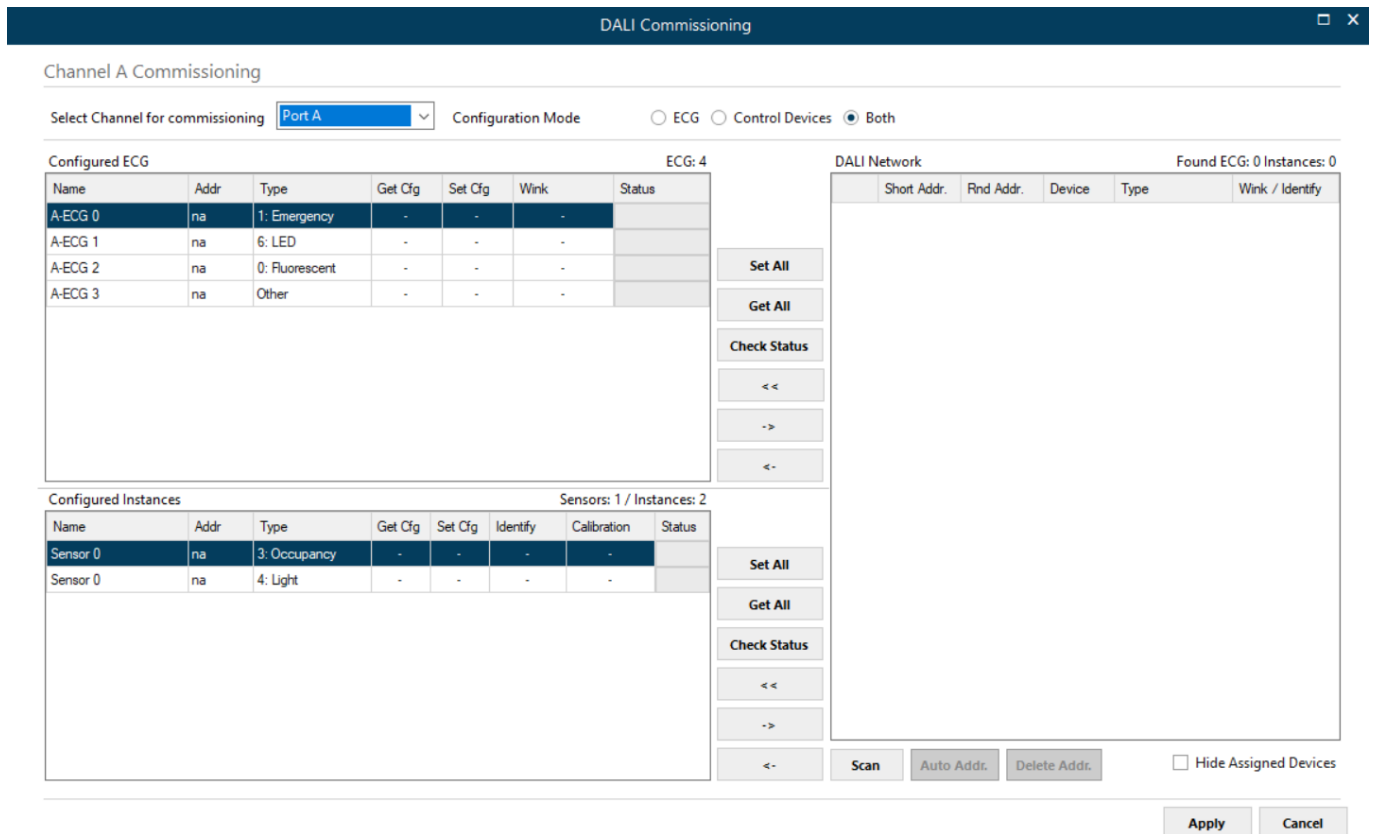

Figure A.7 DALI commissioning window

If having product version / template project supporting 2 DALI channels, channel to commission must be selected between 'Port A' (top of the device) or 'Port B' (bottom of the device). In case of version supporting single DALI channel, no selection is possible.

If devices have been added to the configuration (see previous section 'Device declaration in project') a list of ballasts will appear in Configured ECG and a list of instances will appear in Configured Instances.

There is also a 'DALI network' area that will show DALI scan results, empty by now.

In order to start a DALI network scan, select suitable DALI channel (if applicable) and then click on button 'Scan':

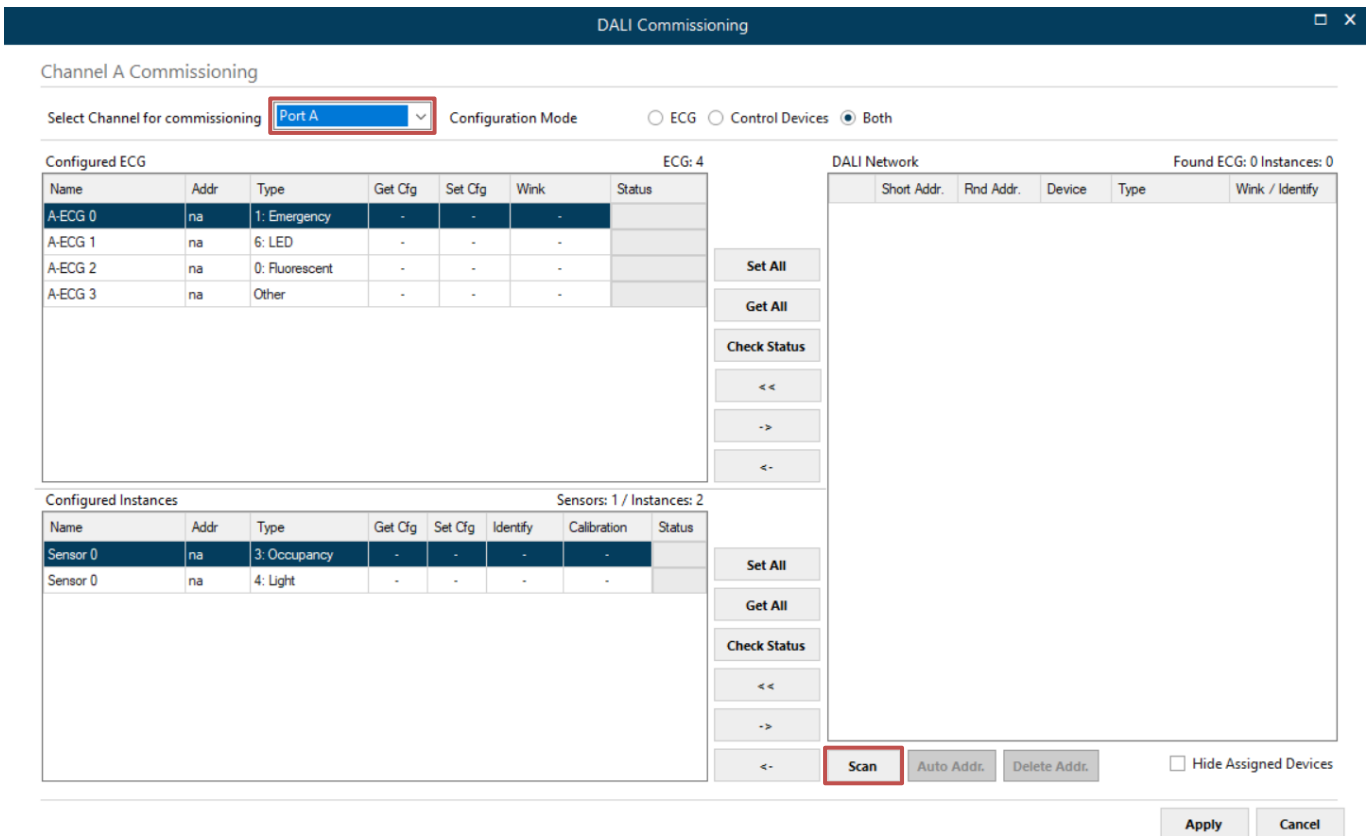

Figure A.8 Starting DALI scan process

Discovered devices will appear in the 'DALI Network' area, as soon as they are scanned. Network scan might take from several seconds up to a few minutes, depending on number of devices to scan.

Field 'Addr' in list of 'DALI Network' will indicate 'na' if device has no associated group address (typical for new devices/factory settings) or a 0..63 value for its short address if device has already been given a short address.

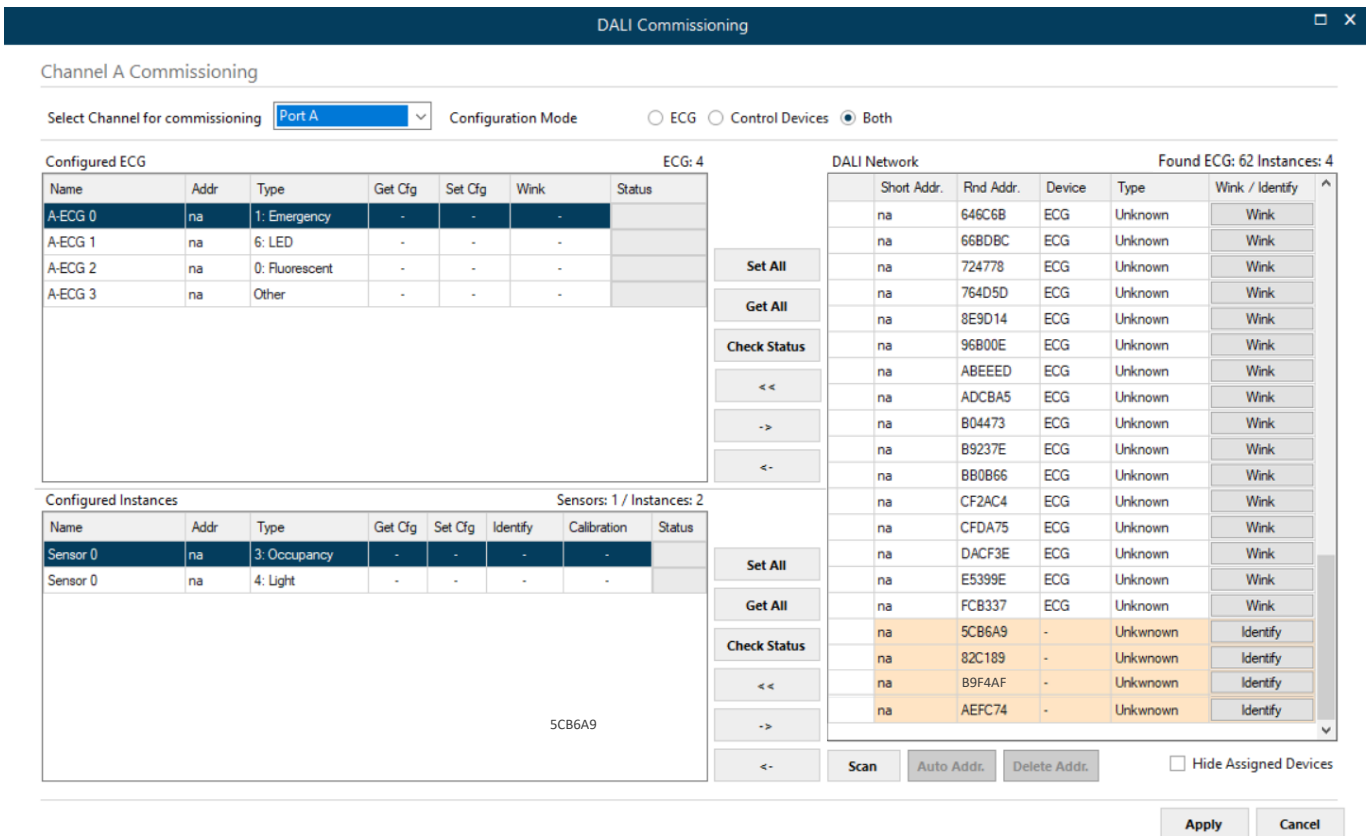

Figure A.9 Example of scan results

After scan is done, total number of found devices will be shown in 'DALI Network:' label. Note that type column will fill only if device has a short address assigned, if not, type cannot be read.

Next step is associating a short address between 0 to 63 to each found ballast. To do so, following options are possible:

1. Identify the device in the installation with the Wink button, and then double click in short address field of the device in DALI Network window, and assign it an address 0..63.
2. Use the Auto Addr. Button to automatically assign a correlative address to each ballast.

Address of each ballast can be deleted at any time, using button Delete Addr. Multiple selection is possible (using Shift and Control keys together with mouse-clicks).

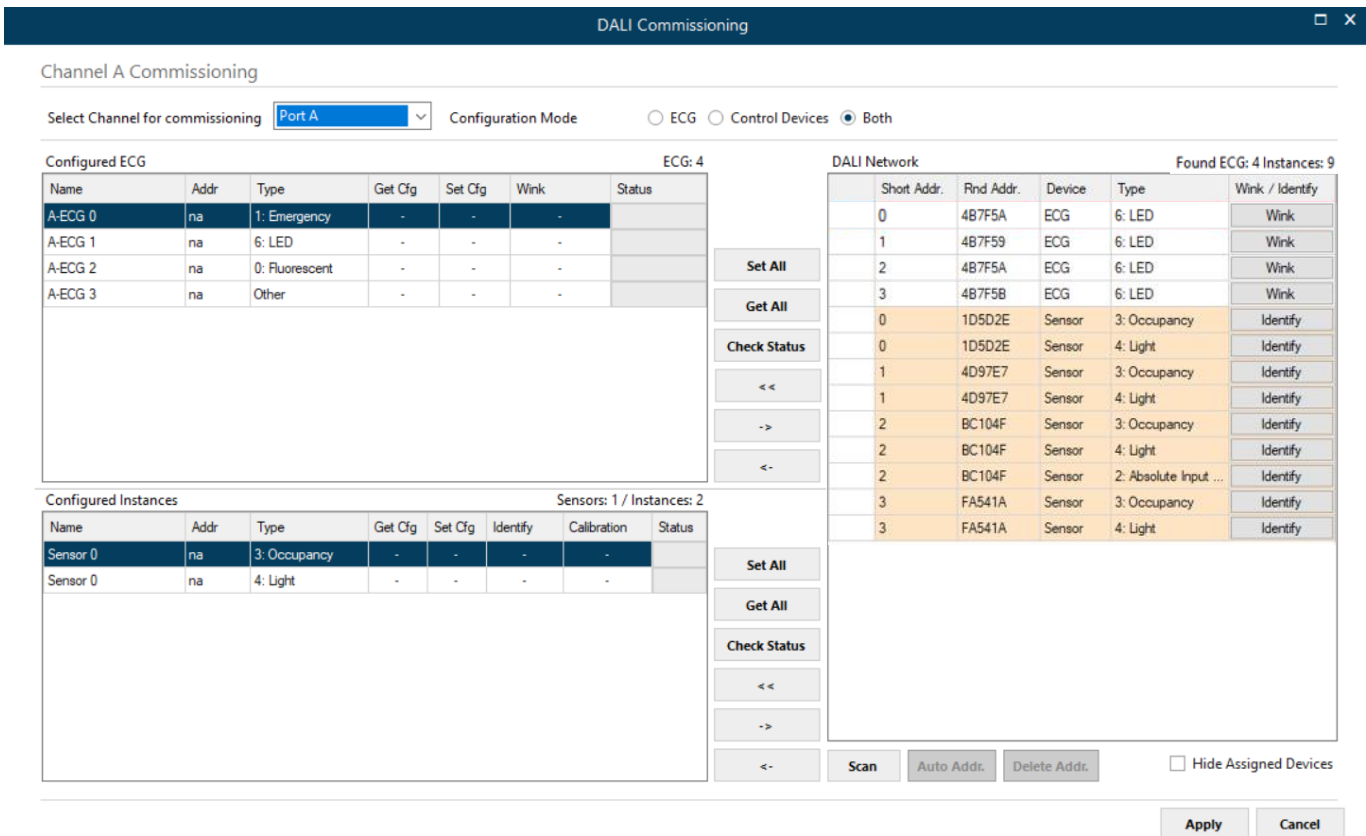

Figure A.10 Shot address association

Once each device has a short address, 'Wink' functionality in "DALI Network" window is available for each one. Wink functionality sets the ballast at maximum and minimum level while it is activated, allowing to identify the physical location of the ballast in the installation. After identifying it in the installation, change in short address might be desired.

After address association, devices can be added in config. There are two ways for doing that:

- Button '<<': Selected ballast or ballasts in 'DALI Network' window will be added as a new ballast in 'Configured ECG' window. It allows multiple selection of ballasts from DALI Network window (using 'shift' or 'control' keys).
- Button '<-': Selected ballast in 'DALI Network' window will be associated to existing/configured ballast in 'Configured ECG' window.

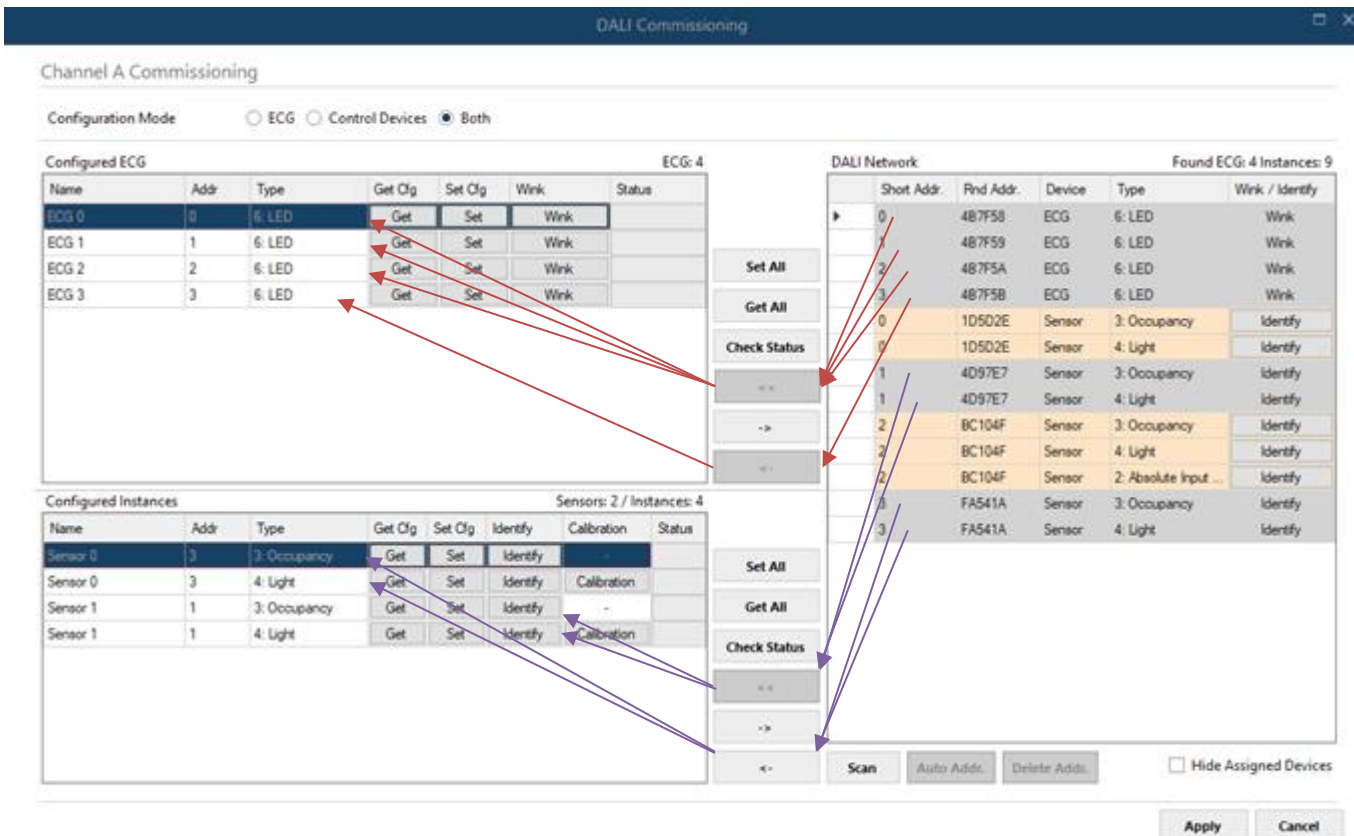

Figure A.11 Functionality of '<<' and '<-' buttons

In Figure's example, we'll associate LED ballasts with short addres 0, 1 and 2 to existing ballasts (with '<-' button), and add ballast from short addresses 3 as new ballasts in the configuration (with '<<' button). Then we'll associate instances of sensor with short address 3 to existing instances (with '<-' button), and add instances from short addresses 1 as new ones in the configuration (with '<<' button).

Figure above shows the result. Now configured ECG's and configured Instances contains actual ballasts and sensor instances in the installation, each with its own short addres. At this point, it's possible to:

- **Remove the ballast from configuration** (button '<->'). This will move them back to 'DALI Network' area.
- **Wink the ballast to identify it in the installation** (button 'Wink', on each ECG).
- **Get the ballast configuration parameters** (button 'Get' on each ECG, or 'Get All' below the window). Warning, getting the configuration of a ballast will overwrite all configured parameters in MAPS config for that ballast (preset levels, group addressing, scenes, ...)
- **Set the ballast configuration parameters for each ballast** (button 'Set' on each ECG, or 'Set All' below the window).
- **Calibrate** (only for lighting sensors) to calibrate sensor measures with real lux measurement in the surface area.

Finally, pressing button 'Apply' will apply all changes to actual configuration in MAPS, and close the window.

Keep in mind that process done at window DALI commissioning changes configuration of parameters in DALI network, but it's still necessary to configure further parameters in Intesis and sending configuration file to Intesis using 'Send/Receive' tab of configuration section.