



User Guide



**POWER
MEASUREMENT**

Notices

For further assistance
please contact us at:



Worldwide Headquarters

2195 Keating Cross Road
Saanichton, BC
Canada V8M 2A5
Tel: 1-250-652-7100
Fax: 1-250-652-0411
Email: support@pwrn.com

www.pwrn.com

© 2004 Power Measurement
Printed in Canada
Revision Date: Aug. 31, 2004
70000-0248-00

Danger



This symbol indicates the presence of dangerous voltage within and outside the product enclosure that may constitute a risk of electric shock, serious injury or death to persons if proper precautions are not followed.

Caution



This symbol alerts the user to the presence of hazards that may cause minor or moderate injury to persons, damage to property or damage to the device itself, if proper precautions are not followed.

Note



This symbol directs the user's attention to important installation, operating and maintenance instructions.

Installation Considerations

Installation and maintenance of the ION 7550 / ION 7650 meter should only be performed by qualified, competent personnel that have appropriate training and experience with high voltage and current devices. The meter must be installed in accordance with all Local and National Electrical Codes.

DANGER

Failure to observe the following instructions may result in severe injury or death.

- ◆ During normal operation of the ION 7550 / ION 7650 meter, hazardous voltages are present on its terminal strips, and throughout the connected potential transformer (PT), current transformer (CT), digital (status) input, control power and external I/O circuits. PT and CT secondary circuits are capable of generating lethal voltages and currents with their primary circuit energized. Follow standard safety precautions while performing any installation or service work (i.e. removing PT fuses, shorting CT secondaries, etc.).
- ◆ The terminal strips on the meter base should not be user-accessible after installation.
- ◆ Do not use digital output devices for primary protection functions. These include applications where the devices perform energy limiting functions or provide protection of people from injury. Do not use the ION 7550 / ION 7650 in situations where failure of the devices can cause injury or death, or cause sufficient energy to be released that can start a fire. The meter can be used for secondary protection functions.
- ◆ Do not HIPOT/Dielectric test the digital (status) inputs, digital outputs, or communications terminals. Refer to the label on the ION 7550 / ION 7650 meter for the maximum voltage level the device can withstand.

CAUTION

Observe the following instructions, or permanent damage to the meter may occur.

- ◆ The ION 7550 / ION 7650 meter offers a range of hardware options that affect input ratings. The ION 7550 / ION 7650 meter's serial number label lists all equipped options. Applying current levels incompatible with the current inputs will permanently damage the meter. This document provides installation instructions applicable to each hardware option.
- ◆ The ION 7550 / ION 7650 meter's chassis ground must be properly connected to the switchgear earth ground for the noise and surge protection circuitry to function correctly. Failure to do so will void the warranty.
- ◆ Terminal screw torque: Barrier-type (current, voltage, and relay terminal screws): 1.35 Nm (1.00 ft-lbs.) max. Captured-wire type (digital inputs/outputs, communications, power supply): 0.90 Nm (0.66 ft-lbs.) max.

FCC Notice

This equipment has been tested and found to comply with the limits for a Class A digital device, pursuant to Part 15 of the FCC Rules. These limits are designed to provide reasonable protection against harmful interference when the equipment is operated in a commercial environment. This equipment generates, uses, and can radiate radio frequency energy and, if not installed and used in accordance with the instruction manual, may cause harmful interference to radio communications. Operation of this equipment in a residential area is likely to cause harmful interference in which case the user will be required to correct the interference at his own expense. The Ringer Equivalence Number (REN) for the ION 7550 / ION 7650 optional internal modem is 0.6. Connection to the ION 7550 / ION 7650 internal modem should be made via an FCC Part 68 compliant telephone cord (not supplied). The ION 7550 / ION 7650 cannot be used on a public coin phone service or party line services.

Network Compatibility Notice for the Internal Modem

The internal modem in meters equipped with this option is compatible with the telephone systems of most countries in the world, with the exception of Australia and New Zealand. Use in some countries may require modification of the internal modem's initialization strings. If problems using the modem on your phone system occur, please contact Power Measurement Technical Support.

Standards Compliance



CSA: Certified to CAN/ CSA C22.2 No.1010-1



Certified to UL 3111

Limitation of Liability

Power Measurement Ltd. ("Power Measurement") reserves the right to make changes in the device or its specifications identified in this document without notice. Power Measurement advises customers to obtain the latest version of the device specifications before placing orders to verify that the information being relied upon by the customer is current.

Regardless of whether any remedy set forth herein fails of its essential purpose, except to the extent the following limitation is prohibited by applicable law, Power Measurement shall not, in any event or under any legal claim or theory (whether based on contract, indemnity, warranty, tort (including negligence and strict liability) or otherwise), be liable to the original purchaser or any other person or entity for special, indirect, incidental, punitive, liquidated, special or consequential damages whatsoever with respect to any purchased product, including, without limitation, business interruption, loss of use, profit or revenue, even if Power Measurement has been advised of the possibility of such damages. To the extent that a limitation or exclusion of consequential damages are prohibited by applicable law, then Power Measurement's liability shall be limited to twice the amount of the relevant purchased product. Not to limit the foregoing, a) Power Measurement shall not be liable for any claim (other than a claim solely for the breach of one of the above Warranties that is made in accordance with the above described procedures) made by the original purchaser, its employees, agents, or contractors for any loss, damage, or expense incurred due to, caused by, or related to any purchased product; and b) the above Warranties are the original purchaser's exclusive remedy and Power Measurement hereby expressly disclaims all other warranties, express or implied, including, without limitation, warranties of non-infringement and the implied warranties of merchantability and fitness for a particular purpose.

These limited Warranties shall not apply to any product that has been subject to alteration, accident, misuse, abuse, neglect or failure to exactly follow Power Measurement's instructions for operation and maintenance. Any technical assistance provided by Power Measurement's personnel or representatives in system design shall be deemed to be a proposal and not a recommendation. The responsibility for determining the feasibility of such proposals rests with the original purchaser and should be tested by the original purchaser. It is the original purchaser's responsibility to determine the suitability of any product and associated documentation for its purposes. The original purchaser acknowledges that 100% "up" time is not realizable because of possible hardware or software defects. The original purchaser recognizes that such defects and failures may cause inaccuracies or malfunctions. Only the terms expressed in these limited Warranties shall apply and no distributor, corporation or other entity, individual or employee of Power Measurement or any other entity is authorized to amend, modify or extend the Warranties in any way.

The information contained in this document is believed to be accurate at the time of publication, however, Power Measurement assumes no responsibility for any errors which may appear here and reserves the right to make changes without notice.

Power Measurement, ION, ION Enterprise, MeterM@il, WebMeter and "smart energy everywhere" are either registered trademarks or trademarks of Power Measurement. All other trademarks are property of their respective owners.

Covered by one or more of the following patents:

U.S. Patent No's 6751562, 6745138, 6737855, 6694270, 6687627, 6671654, 6671635, 6615147, 6611922, 6611773, 6563697, 6493644, 6397155, 6186842, 6185508, 6000034, 5995911, 5828576, 5736847, 5650936, D459259, D458863, D443541, D439535, D435471, D432934, D429655, D429533, D427533.

Table of Contents

Chapter 1	Introduction	9
Chapter 2	Front Panel	17
Chapter 3	Templates, Frameworks and Firmware	45
Chapter 4	Basic Setup	51
Chapter 5	Security	55
Chapter 6	Communications	63
Chapter 7	Third-party Protocols	83
Chapter 8	Time	107
Chapter 9	Demand	113
Chapter 10	Inputs / Outputs	117
Chapter 11	Energy Pulsing	127
Chapter 12	Logging	133
Chapter 13	Revenue	145
Chapter 14	Power Quality	151
Chapter 15	Test Mode	157
Chapter 16	Meter Resets	161
Chapter 17	Alerting	167
Chapter 18	Setpoints	173
Chapter 19	Power Availability	177
Chapter 20	Reporting	185



chapter
1

Introduction

This manual discusses ION 7550 and ION 7650 meter features and provides configuration instructions. Throughout the manual, the term “meter” refers to both meter models. All differences between the models, such as a feature specific to one model, are indicated with the appropriate model number.

By the time you are ready to use this guide, your meter should be installed, most basic setup should have been performed, and communications/basic operation should have been verified. If the unit is not yet installed and operational, refer to the Installation Guide shipped with the meter.

This chapter provides an overview of ION 7550 and ION 7650 meters, and summarizes many of their key features.

In This Chapter

◆ ION 7550 and ION 7650 Meters	10
The ION meter in an Enterprise Energy Management System	11
◆ Meter Features	12
Data Display and Analysis Tools	12
Supported Protocols	13
Communications Options	13
Digital and Analog I/O Options	13
ION Enterprise Software Support	14
ION Setup Software Support	16
◆ Getting More Information	16

ION 7550 and ION 7650 Meters



The ION 7650

ION 7550 and ION 7650 intelligent metering and control devices provide revenue-accurate, true RMS measurements of voltage, current, power and energy, and are complemented by extensive I/O capabilities, comprehensive logging, and advanced power quality measurement and compliance verification functions. The meters come with an extensive selection of pre-configured data screens and measurements, so you can use the meters “out of the box” or customize them to fit your unique requirements.

ION 7550 and ION 7650 meters can replace numerous transducers, traditional meters, and control circuits. You can integrate the meters with ION[®] software or other energy management, SCADA, automation and billing systems, using multiple industry-standard communication channels and protocols.

Common Meter Applications

- ◆ Revenue metering
- ◆ Substation automation
- ◆ Power quality monitoring (with Flicker)
- ◆ Commercial/industrial operations metering
- ◆ Demand and power factor control
- ◆ SCADA (supervisory control and data acquisition)
- ◆ Distributed generation (generator) monitoring and control

The ION meter in an Enterprise Energy Management System

You can use ION 7550 and ION 7650 meters as standalone devices, but their extensive capabilities are fully realized when used with ION software as part of an enterprise energy management (EEM) system.

EEM systems give energy suppliers, service providers, and large industrial and commercial energy consumers the tools to meet all the challenges and opportunities of the new energy environment. EEM systems use real-time information and control to directly address a broad range of requirements throughout the power delivery chain and across an entire enterprise. These systems offer an integrated solution to managing new billing structures, distributed generation, energy purchasing, energy cost control, operational efficiency, and power quality and reliability.

Applications that include the meter typically require additional equipment. Display and analysis software tools are almost always used to manage, interpret and distribute the data measured or logged by a meter. There are usually a variety of tools used, and often these tools are connected using different communications standards and protocols. In many cases, a meter must also provide control capabilities and device-level data sharing.

The meter can adapt to many situations. Advanced communications allow data to be shared simultaneously across multiple networks, built-in I/O provides monitoring and control capabilities, and a variety of display and analysis tools to monitor your power system.

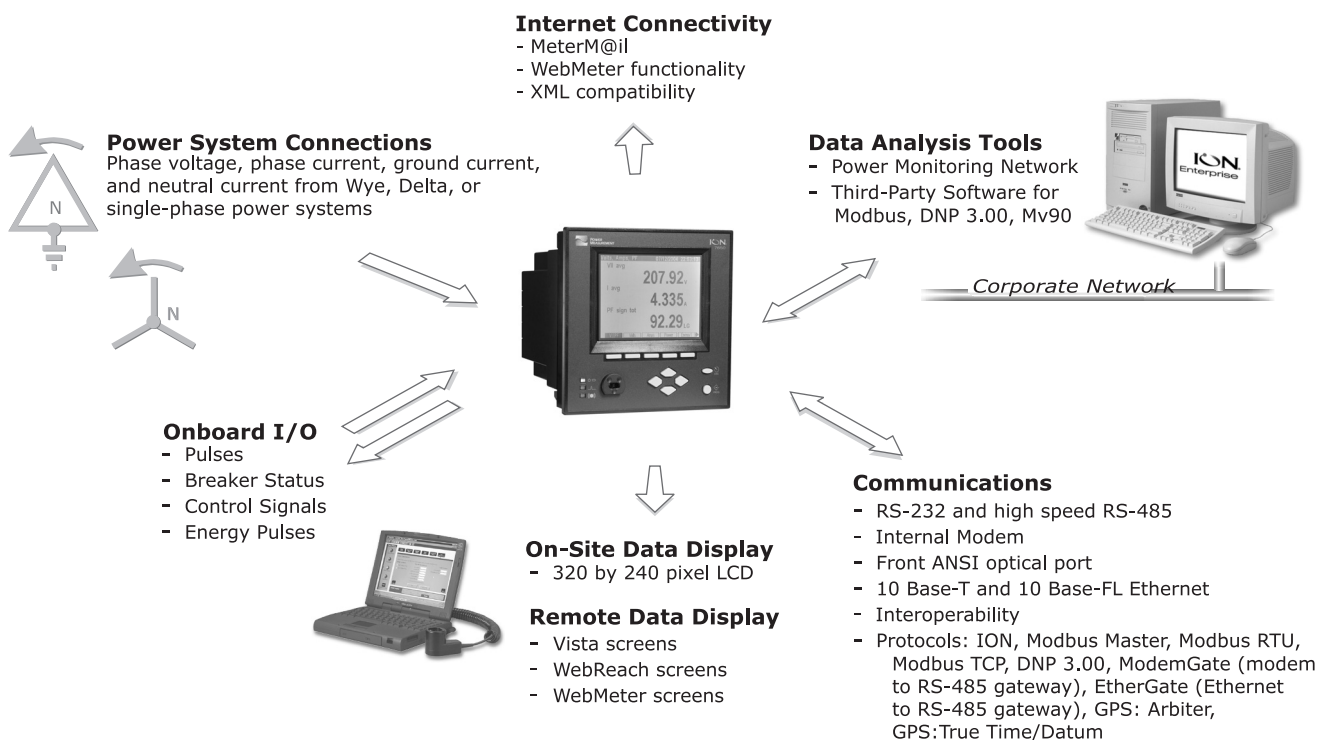

Meter Features

Your meter includes an impressive array of standard features. See below for an overview.

Data Display and Analysis Tools

Display and analyze meter data with a wide variety of tools.

The Front Panel

Use the meter's front panel interface for local monitoring and standalone applications. The bright LCD display lets you view real-time values and perform basic device configuration. The front panel is often used in combination with an ION software system, providing an interface for field personnel.

 **NOTE**

TRAN (transducer) model meters do not have a front panel.

WebMeter[®] Embedded Web Server Feature

Ethernet meters include WebMeter functionality; an on-board web server that provides quick and easy access to real-time energy and basic power quality information without special software. The built-in web pages display a range of energy and basic power quality information through the web-enabled device; these pages even support basic meter configuration tasks.

MeterM@il[®] Internal E-Mail Client Feature

Configure the meter to automatically email high-priority alarm notifications or scheduled system-status update messages to anyone, anywhere within the facility or around the world. Specify the type of event that triggers an email alert, such as power quality disturbances or logged data at any pre-determined interval, and have your ION software administrator program the meter to respond with a MeterM@il message when these events occur. MeterM@il messages are received like any email message over a workstation, cell phone, pager, or PDA.

XML Compatibility

Your meter can exchange information using industry-standard XML format. This simple machine-readable format supports easy integration with custom reporting, spreadsheet, database, and other applications.

Supported Protocols

You can integrate the meter into various industry-standard networks. Data that the meter measures can be made available to other devices using Modbus RTU, Modbus/TCP, and DNP 3.0 protocols, as well the MV-90 translation system. You can also configure the meter to import data from other devices on these networks. With these advanced communications functions, the power of the meter can be utilized in most existing power monitoring systems. Any data display and analysis software that works with Modbus RTU or DNP 3.0 devices also functions with the meter.

Communications Options

The standard meter includes a selectable RS-232/RS-485 port (the factory default is RS-232), a high-speed RS-485 port, and an ANSI Type II front optical port for communications in the field. Ordering options include a 10Base-T Ethernet port or 10Base-FL fiber-optic port, and a 33.6 kbps internal modem (both FCC and CTR-21 compliant). Depending on the hardware options purchased, up to five separate ports can communicate simultaneously.

 **NOTE**

The communications card is retrofittable – it can be replaced while the meter is in the field.

Digital and Analog I/O Options

The meter's digital inputs and outputs connect to the captured-wire terminals near the base of the unit. Additionally, a LED on the front panel is configured for energy pulsing. You can also order an optional analog I/O card with your meter.

 **NOTE**

The I/O card is retrofittable – it can be replaced while the meter is in the field.

Digital Inputs

The meter contains eight self-excited digital inputs capable of detecting a pulse rate of 20 pulses/second and timestamping transitions with 1ms resolution. They can be used for monitoring external contacts or pulse counting applications. These inputs use a current sensing technique to monitor contact status by providing an internal 30 VDC supply for self-excitation.

Relay Outputs

The meter contains four solid-state Form A outputs and three mechanical Form C relays. The solid-state outputs have a maximum voltage rating of 30 VDC and maximum current rating of 100 mA. The mechanical relays are rated at 250 VAC / 30 VDC and can switch up to 10 A loads.

Analog Inputs and Analog Outputs

The meter offers an optional Analog I/O expansion card with numerous options:

- ◆ four 0 to 1 mA analog inputs
- ◆ four 0 to 20 mA analog inputs
- ◆ four -1 to 1 mA analog outputs
- ◆ four 0 to 20 mA analog outputs
- ◆ four 0 to 20 mA analog inputs & four 0 to 20 mA outputs
- ◆ four 0 to 1 analog inputs and four -1 to 1 mA analog outputs

NOTE

All options have an additional eight digital inputs on the card.

ION Enterprise Software Support

The complete ION Enterprise software package integrates the meter into a fully networked information system with other meters and local and wide-area computer networks. ION Enterprise is recommended for all power monitoring systems where advanced analysis and control capabilities are required.

ION Enterprise provides tools for managing your power monitoring network, logging data, analyzing real-time and logged data, generating power system reports, and creating custom functionality at the meter level.

Vista

Vista presents a graphical view of your power system, allowing you to view and analyze real-time data from power meters and historical data from the ION database. Vista reports on the status of your system components, informing you of alarm conditions and providing you with control capabilities for initiating intelligent device functions or actuating field machinery. Vista includes sophisticated tools for analyzing real-time and logged power data and system events.

For more information, refer to the Vista section in the online *ION Enterprise Help*.

WebReach

The WebReach component of ION Enterprise adds thin-client support functionality to the ION Enterprise software. With the WebReach feature you can use the web browser from any machine on your network to view the Vista diagrams of all the meters on your network, regardless of whether they are located locally or across the country. You can create custom screens in Vista for display in your web browser, including real-time numeric data, background graphics or diagrams, and basic views of event, data and waveform logs.

Reporter

Reporter lets you define and create comprehensive database reports using Microsoft Excel. Configured Power Quality, Load Profile, Energy and Demand, and EN50160 reports are included with Reporter.

For more information, refer to the Reporter section in the online *ION Enterprise Help*.

Management Console

Management Console is used to build your ION Enterprise power-monitoring network to reflect the way the physical communications network is wired, so ION Enterprise software can communicate with your devices. The network is created using sites, servers, modems, and intelligent devices that can be added, removed, configured, or duplicated.

You can access the following tools from the Management Console menus:

- ◆ **Diagnostics Viewer** is the primary source of troubleshooting information in ION Enterprise.
- ◆ **Device Upgrader** lets you upgrade the operating software inside an ION meter.
- ◆ **Remote Modem Setup** lets you set up modems for remote sites.
- ◆ **Database Manager** lets you manage your ION Enterprise databases with both manual tasks and scheduled tasks.
- ◆ **User Manager** lets you configure ION Enterprise software user accounts that define different operations permitted within the ION software, such as viewing meter data, performing control actions, or configuring the meters.
- ◆ **License Manager** lets you upgrade the number of devices you can have without re-installing the software.

For more information, refer to the Management Console section in the online *ION Enterprise Help*.

Designer

Designer lets you customize the operation of hardware nodes, such as ION meters, and software nodes, such as the ION Virtual Processor, the Log Inserter, and the Query Server. Designer uses a WYSIWYG graphical user interface to pictorially represent a node's configuration (i.e., how the different ION modules are linked together in a framework). In addition to giving you the ability to change the settings of any ION module, Designer also lets you change existing links between modules, add new links, add new modules or delete modules. Designer helps you visualize the logic when you are programming custom functionality in an ION device.

For more information, refer to the Designer section in the online *ION Enterprise Help*.

ION Setup Software Support

ION Setup is a software tool designed specifically to configure and test meters. ION Setup offers an intuitive graphical interface for performing basic meter setup, installing templates into meters, viewing real-time and reset accumulated values, verifying meter calibration and measurements, and setting up advanced security.

Getting More Information

Additional information is available from Power Measurement:

- ◆ visit our web site at www.pwrn.com
- ◆ contact your local Power Measurement representative
- ◆ contact Power Measurement directly

Documents that are related to the installation, operation and application of the meter are as follows:

ION 7550 / ION 7650 Installation Guide

This brief manual is shipped with each meter. It details the mounting, wiring and basic setup of the device.

ION Reference

The ION Reference describes ION architecture (the common software architecture in all ION devices) and provides an explanation for each of the ION modules.

Online ION Enterprise Help & Online ION Setup Help

In-depth online help systems for ION Enterprise and ION Setup software.

Technical Notes

Technical notes provide instructions for using meter features and for creating custom configurations.

Product Option Documents

These documents include instructions on how to retrofit your current product with your new option, and how to utilize the option.

Protocol Documents

Each protocol document contains information explaining how our products interact with a protocol, such as DNP 3.0, Modicon Modbus, and MV-90.

chapter
2

Front Panel

The meter's front panel is used for both display and configuration purposes. The ¼ VGA display screen and the numerous selection, navigation, and configuration buttons allow quick access to basic meter configuration provided by special setup screens. The front panel also provides access to many other meter functions, such as meter resets.

This chapter provides information about the meter's front panel, including instructions for using the setup menus and for displaying meter values.

In This Chapter

- ◆ **Displaying Data with the Front Panel** **18**
 - Display Screen Types 19
 - Default Front Panel Display Screens 21
- ◆ **Configuring the Meter with the Front Panel** **27**
 - The Front Panel's Main Setup Menu 27
 - Main Setup Menus 29
 - Format Setup Menu 29
 - Display Setup Menu 30
- ◆ **Display Setup** **31**
 - Display Options Module Settings 31
 - Scroll Module Settings 31
 - Display Module Settings 32
 - Creating a Front Panel Reset 33
- ◆ **Custom Front Panel Displays** **34**
 - Display Framework Overview 34
 - Changing Default Display Frameworks 35
- ◆ **Trend Displays** **38**
 - Screen Messages 40
 - Adding New Trend Display Modules 40
- ◆ **Displaying Data from Other Meters** **42**

Displaying Data with the Front Panel

The front panel display provides a detailed graphics and text display that has been factory configured to show many of the parameters measured by the meter.

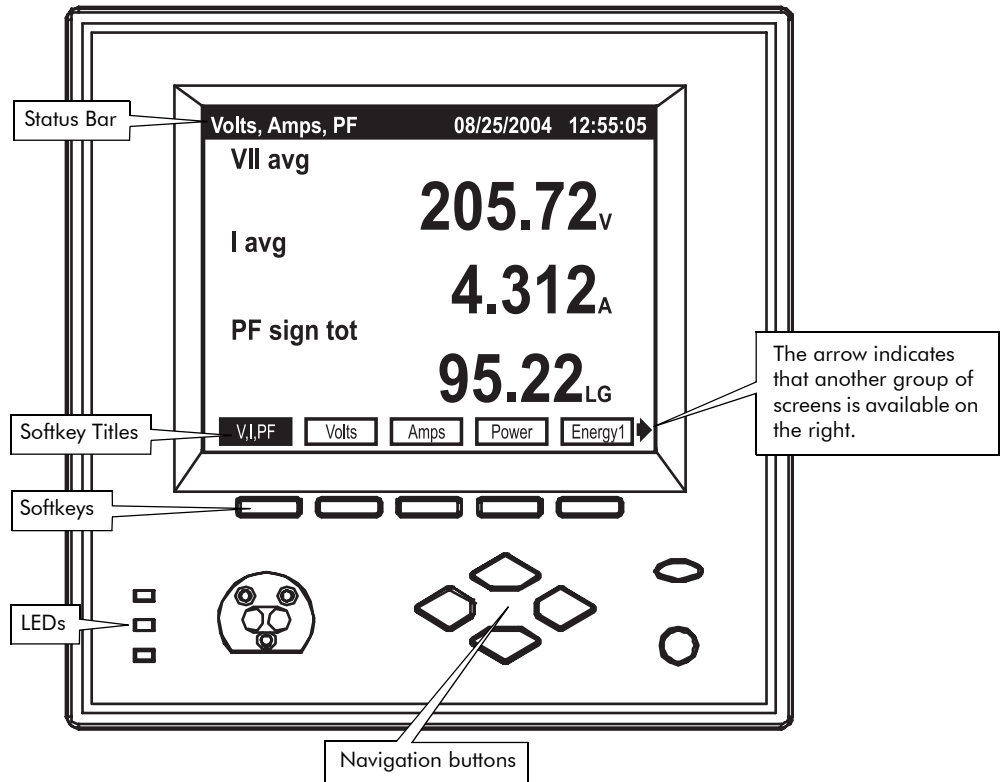

The meter’s display shows numeric data screens, event logs, phasor diagrams, bar graphs, and harmonics histograms.

Using the Front Panel Buttons to Display Data

The front panel has numerous buttons: softkeys, navigation buttons, program buttons. Program buttons are only used when configuring the meter. Use the following buttons to view data on the front panel display screens.

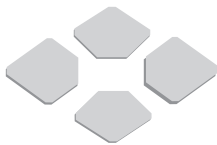

Navigation Buttons

The horizontal navigation buttons (Left/Right keys) select a different set of five Softkey titles to access different data screens. The vertical navigation buttons (Up/Down keys) are used to navigate within certain data display screens, such as within a Trend Display’s graph and log screens or an Event Log screen, once one has been selected.



Softkeys

Pressing the Softkey button selects the data screen available in the corresponding Softkey title.

Front Panel LEDs

The front panel LEDs are as follows:



- ◆ The **green operation LED (top)** should always be on when the meter is in service. Contact Technical Support if this is not the case.
- ◆ The **green LED (middle)** is factory configured to be a Wh (del+rec) pulser. During the course of normal operation, this LED should blink intermittently as the meter measures power system energy.
- ◆ The **red LED (bottom)** on the front panel of the meter is user programmable. Possible applications include sag/swell alarming, setpoint annunciation, and tariff notification. Like all the other outputs on the meter, this port can be controlled by a Digital Output, Pulser, or Calibration Pulser module.

Backlight Operation and Display Contrast

The front panel display is factory configured to dim five minutes after the last button press. If the front panel is dimmed, press any button to return the display to full brightness. The front panel display is adjusted at the factory to the optimal contrast level. Use the Display Setup menu to adjust the contrast, if necessary.

Status Bar

The Status Bar of the meter is located along the top of all display screens. When in data display mode, the Status Bar shows the date in MM/DD/YYYY format (configurable), the current local time in 24 hour format, and the data display screen title.

Display Screen Types

The meter's front panel displays measurements, configurable settings, and current configuration data in various forms. These data display screens are described below.

Numeric Displays

Numeric displays show multiple parameters at a time: two, three, three with a timestamp, four, eight, ten (shown), or twenty. When displaying numeric values for current and power quantities, the front panel shows resolution to three decimal places by default. All other values are displayed to two decimals of accuracy. If you want to see finer resolutions, use Vista software to display the data.

NOTE

If the front panel is unable to read a numeric value, or if the value is not available, it displays a dash (—).

Automatic Units

The front panel automatically scales the units for basic measurements, such as voltage, current and power parameters. For example, a measurement of 2,000 Watts is displayed as 2.000 kW. A measurement of 2,000,000 Watts is displayed as 2.000 MW. The meter makes these conversions using your PT and CT ratios.

NOTE

The meter only performs these automatic units if the measurement is derived solely from the Power Meter module's output.

Phasor Diagram Displays

Phase information is displayed in phasor diagram format. Phasor diagrams are accompanied by tables that state the angle and magnitude of each phasor. In cases where phasors are too small to be represented graphically, they are only shown as table entries.

Event Log Displays

Event Log displays alert you to recent events written to the meter's event log. Use the vertical (Up/Down) navigation buttons to move through the list.

For details on altering the meter's Event Log characteristics, such as log depth and logging frequency, see the Logging chapter.

Nameplate Displays

Like Event Log displays, Nameplate displays show information in tabular format. Default nameplates show owner, meter, and power system details.

See the Templates, Frameworks and Firmware chapter for details on configuring the TAG strings.

Histogram Displays

Harmonics content is displayed in histogram format. Harmonics are displayed from the 2nd to the 63rd harmonic, with Total Harmonic Distortion (THD) values displayed above the histogram (K Factor and Crest Factor only appear in current harmonic histograms).

Use the vertical navigation buttons on the meter front panel to select individual harmonics (from 2nd to 40th) in the histogram and view data specific to each of them (V_1 , V_2 , V_3 , I_1 , I_2 , and I_3 only).

An arrow  appears below the harmonic selected. Harmonic magnitude is displayed as an absolute value and as a percentage of the fundamental. The phase angle of each harmonic is also provided. To return to the THD values, position the arrow below the fundamental.

Trend Bar Graph Displays

Bar graph displays can show up to four real-time (numeric) parameters along with their upper and lower extremes.

Each bar graph automatically scales its output based on the magnitude of its extremes. The real-time value of each bar graph is displayed to the right of the graph.

NOTE

Scaling is applied separately to each bar graph in the display. Do not compare the magnitudes of two values based on the size of their bars.

Trend Displays

The Trend Display screen graphs the historical data of up to four different parameters simultaneously. A movable cursor, consisting of the intersection of a vertical line and a horizontal line, displays the value and timestamp of any plotted data within a parameter. The cursor displays the values of one parameter at one time only. Use the Up and Down navigation keys to move from one parameter to another.

In addition, a Trend Display log screen displays data logs for any graphed parameter – up to 3360 logs for each parameter. That is equivalent to 35 days worth of 15 minute data. The graph is updated when a new set of values is recorded. The highest supported update speed is once per second.

The front panel displays three preconfigured trending screens: V-Trend (voltage), I-Trend (current), and P-Trend (power).

Default Front Panel Display Screens

The meter is factory configured to display a number of data screens on its front panel:

- ◆ 41 display screens for all ION 7550 meters and ION 7650 meters without EN50160
- ◆ 50 display screens for ION 7650 meters with the EN50160 ordering option

Each screen is accessible with a corresponding Softkey. See the “Using the Front Panel Buttons to Display Data” section for instructions on using the softkeys to display data.

NOTE

Each display screen is listed with the corresponding softkey name and the screen title.

Screens Shown in Display Cycle

Ten data display screens are included in the automatic display cycle. By default, the front panel scrolls repeatedly through the following screens in the following order:

1. V,I,PF (Volts, Amps, PF)

This numeric display screen contains the average line-to-line voltage, average current, and the total signed power factor.

2. Volts (Volts)

This numeric display screen shows the line-to-line voltages Vll ab, Vll bc, and Vll ca.

3. Amps (Amps)

This is a numeric screen containing currents I a, I b, and I c.

4. Power (Total Power)

This numeric display screen contains total kW, kVAR, and kVA values.

5. Energy1 (Energy Delivered)

This numeric display screen shows delivered (imported) energy values for kWh, kVARh, and kVAh.

6. Demand1 (Demand Delivered)

This numeric display screen contains delivered values (kW, kVAR, and kVA) in the previous demand period. By default, these values come from a sliding window demand (rolling block) calculation.

7. Pk Dmd1 (Peak Demand Del)

This is a numeric display screen with timestamps containing maximum delivered demand values for kW, kVAR, and kVA. The timestamps show the date and time at which the values were last updated. By default, these values come from a sliding window demand calculation.

8. V Bar

9. I Bar

10. P Bar (Voltage, Current, and Power Bar Graphs)

These three screens are trend bar graph displays. They show real time values for voltage (Vll ab, Vll bc, Vll ca, Vll avg), current (I a, I b, I c, I avg) and power (kW tot, kVAR tot, kVA tot, PF lag tot). The bar graphs also indicate the maximums and minimums recorded for these values.

Additional Data Display Screens

Most of the default data screens are not included in the default scrolling cycle. To view the other display screens, find the group of five Softkey titles that contains the data screen you want, and press the corresponding Softkey.

11. Summary1 (Volts/Amps Summary)

This numeric display provides many important voltage, current, phase, and frequency measurements on a single screen.

12. Summary2 (Power Summary)

This numeric display provides real, reactive, and apparent power measurements for phase a, b and c (as well as their total). Signed Power Factor measurements are also displayed on this screen.

13. V Trend (Voltage Trend Display)

The voltage trend display graphs the VII avg trend. Each trending display has two views - graph and log - which are accessible via softkeys once you are displaying the trend screen.

14. I Trend (Current Trend Display)

The current trend display graphs the I avg trend. Each trending display has two views - graph and log - which are accessible via softkeys once you are displaying the trend screen.

15. P Trend (Power Trend Display)

The power trend display graphs the KW tot trend. Each trending display has two views - graph and log - which are accessible via softkeys once you are displaying the trend screen.

16. D Inputs (Digital Inputs)

This numeric display screen shows the status of the eight on-board digital inputs. The present state of all inputs is shown (as Off or On) and the number (Cnt) of state changes since the last reset is recorded.

17. DI - I/O (DI on I/O Card)

This numeric display screen contains the status and counters for the digital inputs on the I/O card.

18. D - Output (Digital Outputs)

This numeric display screen contains the mode and status for the relay and solid state outputs.

19. Anlg - I/O (Analog In and Out)

This numeric display screen contains scaled analog inputs (AI_n scaled) and normalized analog outputs (AO_n normalized), where n ranges from 1 to 4 for both inputs and outputs.

20. Phasors (Phasors)

This screen is a phasor diagram display that shows the magnitude and the relative angular difference between all phase voltage (V_a , V_b , V_c , V_4) and current (I_a , I_b , I_c , I_4 , I_5) fundamental components.

21. Name Plt (Name Plate Info)

The Name Plate Info screen contains the following information: Owner, TAG 1 and TAG 2 from the Factory module, firmware revision of the meter, and template version. TAG 1 and TAG 2 typically identify the meter's user and installed location.

NOTE

The OWNER and TAG registers are configurable with ION software and the WebMeter Setup page.

22. Events (Event Log)

The Event Log display alerts you to events written to the meter's event log. DATE, TIME, SOURCE, and EVENT information are provided. Use the Up and Down Navigation buttons to move through the list.

23. Setpoint (Setpoint Status)

This numeric display screen displays the status of the setpoint parameters defined in the Vista Setpoints diagram.

24. Energy2 (Energy Received)

This numeric display screen shows received (exported) energy values for kWh, kVARh, and kVAh.

25. Demand2 (Demand Received)

This numeric display screen shows received power quantities (kW, kVAR, and kVA) in the present demand period. By default, these values are from a sliding window demand (rolling block) calculation.

26. Pk Dmd2 (Peak Demand Rec)

This is a numeric display screen with timestamps. It shows the maximum received demand quantities (kW, kVAR, and kVA) and the time at which they were recorded. By default, these values are from a sliding window demand (rolling block) calculation.

27. THD (Volts and Amps THD)

This numeric display screen contains the total harmonic distortion on all phase voltage and current inputs.

28. V1 Harm**29. V2 Harm****30. V3 Harm****31. V4 Harm (Harmonics)**

These four histogram display screens show the harmonic content on the phase voltage inputs.

32. I1 Harm**33. I2 Harm****34. I3 Harm****35. I4 Harm****36. I5 Harm (Harmonics)**

These five histogram display screens show the harmonic content on the phase current inputs.

37. TOU (Active Rate / Season)

This eight parameter display screen shows kWh delivered values for each all four of the possible time of use (TOU) rates (rates A, B, C, and D).

38. TOU Egy (TOU Energy Del)

This numeric display screen shows the energy (in kWh) delivered for each time of use (TOU) rate (rates A, B, C, and D).

39. TOU Dmd1

40. TOU Dmd2 (TOU Peak Demand 1 and 2)

These two screens are numeric displays with timestamps. Together they show the maximum delivered kilowatts for each time of use (TOU) rate (rates A, B, C, and D). The timestamps show the date and time at which the values were last updated. By default, these values come from a sliding window demand (rolling block) calculation.

NOTE

The four TOU screens may only be important if you are using the meter in a billing application (i.e. you are a power provider). Typically, most power consumers can ignore the Time-Of-Use front panel displays.

41. Avblty (Power Availability)

This numeric display provides the following measurements: availability (with up-time in parts per million), number of nines, and evaluation time (in days).

EN50160 Data and Statistics Displays (ION 7650 meters with EN50160 ordering option only)

The remaining front panel screens display data to help you determine EN50160 voltage compliance. More details about EN50160 are provided in the technical note *Power Quality: ION Meters and EN50160*.

42. PQ Freq (PQ Power Frequency)

This numeric display shows the following EN50160 Power Frequency data: Nominal Frequency, period (10 second) Freq mean, minimum, and maximum. It also shows the EN50160 frequency compliance statistics: Freq N (the number of valid evaluation periods), Freq N₁ (a count of non-compliance), and Freq N₂ (the number of invalid evaluation periods).

43. PQ Vmag1 (PQ Supply Voltage 1)

This bar graph display shows the following EN50160 Voltage Magnitude data for all three voltage phases: period (10 minute) mean, minimum, and maximum.

44. PQ Vmag2 (PQ Supply Voltage 2)

This numeric display shows the following EN50160 Voltage Magnitude compliance statistics for all three voltage phases: mag N and mag N₁.

45. PQ Flk1 (PQ Flicker 1)

This bar graph display shows the following EN50160 Flicker data for all three voltage phases: present Pst, minimum Pst, and maximum Pst.

46. PQ Flk2 (PQ Flicker 2)

This numeric display shows the following EN50160 Flicker data for all three voltage phases: present Pst, present Plt, and compliance statistics (Flick N and Flck N₁).

47. PQ Vdist (PQ Volt Disturbance)

This numeric display shows the following EN50160 Overvoltage and Dip data for all three voltage phases: expected nominal, minimum Dip, and maximum Overvoltage.

48. PQ Vunb (PQ Volt Unbalance)

This numeric display contains the following EN50160 Voltage Unbalance data: V unbal mean, V unbal mean min, V unbal mean max, and compliance indicators (unbal N and unbal N₁).

49. PQ Vhrm1 (PQ Volt Harmonics 1)

This bar graph display shows the following EN50160 Harmonics data: THD mean, THD mean mn, THD mean max for all three voltage phases (10-minute mean values, min and max values are updated every new observation period).

50. PQ Vhrm2 (PQ Volt Harmonics 2)

This numeric display shows EN50160 Harmonics compliance statistics for all three voltage phases: Hrm N, Hrm N₁, Hrm N₂.

Configuring the Meter with the Front Panel

The front panel allows you to setup and configure the meter at its installed location. When you change a setting in the front panel's Setup menu, you are actually altering the setup register value of an ION module.

NOTE

ION module links cannot be added or deleted using the front panel.

You can also use the front panel's Setup menu to quickly reset common cumulative values like kilowatt hours.

The Front Panel's Main Setup Menu

To access the Front Panel's Setup Menu, press that PROG (programming) button. Pressing the ESC (escape) button returns you to the data display screens.

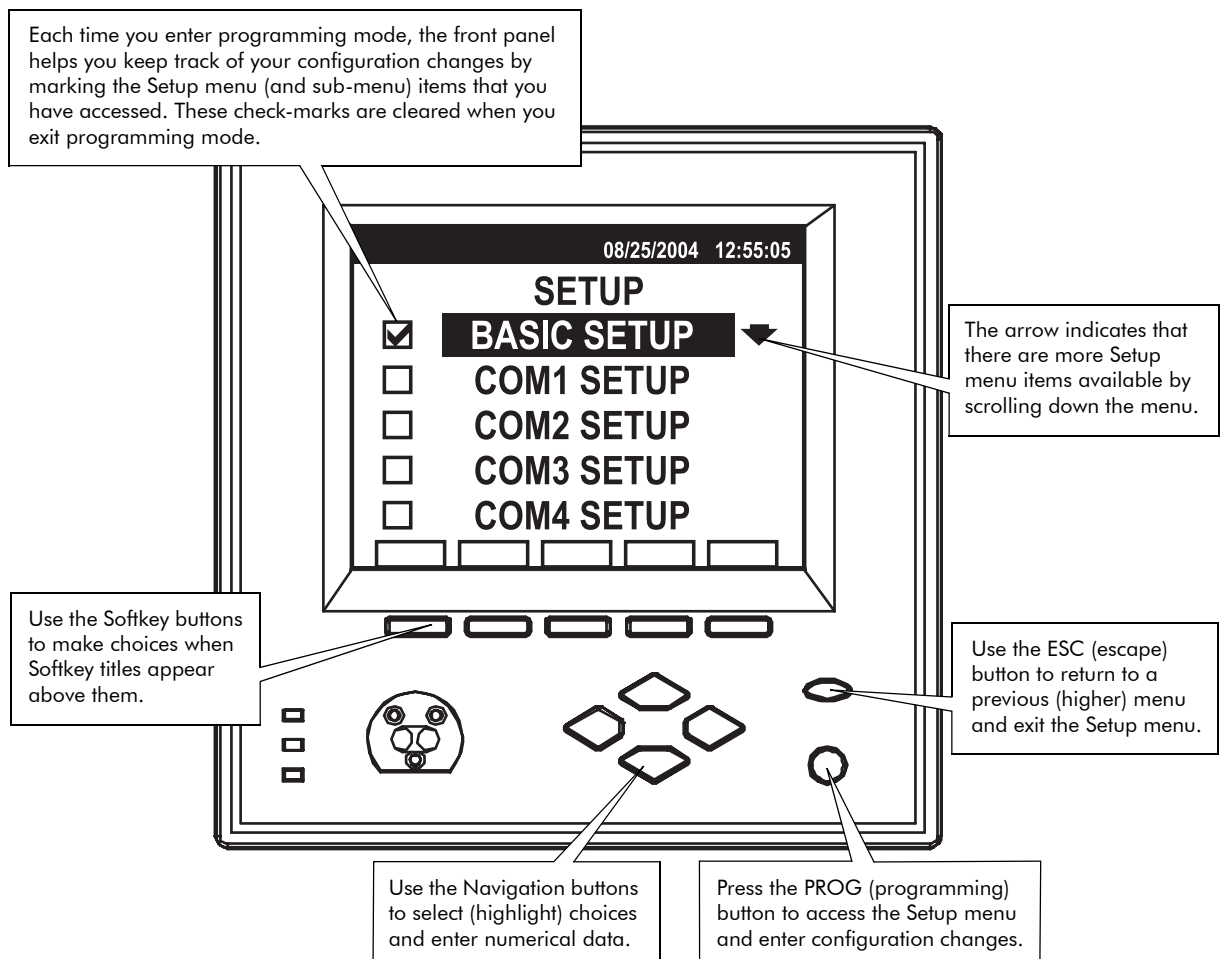

Using the Front Panel Buttons for Configuration

Use the front panel buttons as follows to adjust meter settings:



PROG

Press the PROG (programming) button to access the Setup Menu. Once in programming mode, the PROG button functions just like an Enter key on a computer keyboard. Press the PROG button to select a highlighted item, to accept changes, to enter passwords, and to trigger resets.



ESC

Press the ESC (escape) button to return to a higher menu or abort a configuration change.

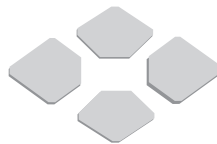

Navigation

Highlight menu items with the vertical (Up/Down) buttons.

Entering numbers: when a digit is highlighted, pressing the Up button increments the number by one, and pressing the Down button decreases it. Move the cursor to an adjacent digit with the horizontal (Left/Right) buttons.



Softkeys

Press a Softkey button when Softkey options become available (when titles appear in the Softkey title bar). Use Softkeys to select the parameters that you want to configure from the various sub-menus.

Passwords

All configuration functions in the front panel are password protected. The password is set to 0 (zero) in the factory. This password allows you to access the Security setup menu and to disable or change the password for a custom value. The front panel only prompts you for the meter password before you make your first configuration change. See the Security chapter for more information on passwords.

Setup Mode Timeout

Once the meter has been configured, the front panel automatically exits the Setup menu five minutes after the last button press is detected. If the front panel returns to data display mode, you must re-enter the Setup menu and provide the valid meter password to resume making configuration changes.

Confirming Configuration Changes

The CONFIRM screen appears whenever you attempt to change the meter's settings through the front panel. This allows you to abort an unwanted configuration change. The front panel also informs you when an entry is out of range. In both cases, press the PROG button to return to the setup screen.



WRITING ERROR Screen

If the CONFIRM screen does not appear for a valid entry, or the display reports a WRITING ERROR, repeat the configuration change. If the problem persists, contact Technical Support.

Main Setup Menus

Press the PROG button to enter the Main Setup menu. The following table summarizes the front panel's Setup menu functions:

Setup Menu Item	Description
Basic Setup	Changes basic settings in the power measurement system configuration
COM1 Setup	RS-232 or RS-485 port setup
COM2 Setup	High-speed RS-485 port setup
COM3 Setup	Optional internal modem setup
COM4 Setup	Front optical port setup
Network Setup	Optional Ethernet network addressing
PQ Setup	Sets the criteria (including nominal voltage) for disturbance detection
Format Setup	Customizes the style and values appearing on the display screens
Display Setup	Customizes display appearance and update rate
Time Setup	Clock and meter time settings
Security Setup	Modify and enable/disable password functions
Meter Resets	Reset functions for factory and user determined cumulative parameters

Highlight the Setup menu item that you want to access, using the vertical navigation buttons. To select the item, press the PROG button.

Format Setup Menu

Use the Format Setup menu to set labeling and formatting preferences for the front panel display.

Numeric Format

The Numeric Format sub-menu contains the following settings:

Digit Group

This specifies the symbols used to delimit thousands and the decimal place holder (i.e. 1000.0 or 1,000.0 or 1 000,0). The default is 1000.0 (no commas, no spaces).

Volts Decimal

Display voltage measurements to one, two, or three decimal places. The default value is two decimal places.

Current Decimal

Display current measurements to one, two, or three decimal places. The default value is three decimal places.

Power Decimal

Display power measurements to one, two, or three decimal places. The default value is three decimal places.

General Format

The General Format sub-menu contains the following settings:

Phase Label

Apply phase labels in any of the following six variations: ABC, RST, XYZ, RYB, RWB, and 123. The default label is ABC.

PF Symbol

Choose Power Factor symbols to be: LD/LG (lead/lag), +/- (positive/negative), or CAP/IND (capacitive/inductive). The default symbols are LD/LG.

Date Format

The front panel can express the date in any of these formats: MM/DD/YYYY, DD/MM/YYYY, and YYYY/MM/DD. The default is MM/DD/YYYY.

Display DST

Choose whether or not to display Daylight Savings Time (DST) on the front panel. The default is Yes.

Display Setup Menu

Configure the following display preferences within Display Setup.

Update Rate

Set the front panel to update its data from every one to every six seconds. The default update time is one second.

Contrast

Set the front panel display contrast level from level zero to level nine where higher numbers represent a sharper level of contrast.

 **NOTE**

Press and hold both the "Up" navigation button and the PROG button at the same time. The contrast level will cycle through its range (0 to 9). Release the buttons at the contrast level you desire.

Display Setup

The meter's front panel display is controlled by three types of ION modules: the Display Options module, the Scroll module, and the Display modules. Use Designer software to configure your displays.

For more information about these modules, see the *ION Reference*.

Display Options Module Settings

The Display Options module contains setup registers that hold data display settings such as contrast level, backlight timeout, daylight savings time, and update time. Settings in the Display Options modules are global, and affect the entire set of front panel display screens.

Setup Register	Function	Default
Contrast	Sets the global contrast setting for the meter display.	7
Display Update Time	Sets the period between data display refreshes (in seconds).	1
Digital Grouping	Sets the numbering format by determining how groups of three digits are separated.	1,000
Demand Lockout Timeout	Sets the minimum time allowed between consecutive demand resets.	2,160,000

Scroll Module Settings

The Scroll module determines the sequence and rate of scrolling for multiple front panel display screens.

Setup Register	Function	Default
Scroll Delay	Sets the time that will elapse between successive pulses on the <i>Trigger</i> outputs when the scroll module is enabled.	6
Wraparound	Designates the last <i>Trigger</i> output (<i>Trigger n</i>) before returning to the first <i>Trigger</i> in the order.	10
Freeze Time	Sets the time (in seconds) that the Scroll module remains "frozen" when pulsed from the <i>Freeze, Up, or Down</i> inputs.	120

The *Trigger* outputs of Scroll module are linked to the inputs of Display modules. When a pulse is sent from the *Trigger* output of a Scroll module to a linked Display module, the Display module shows its information on the front panel.

Display Module Settings

A Display module controls which values are displayed on a display screen, and how these values are presented. Each Display module corresponds to one meter display screen.

The Display module’s *Source* inputs are linked to the numeric parameters you want to display. These parameters are sent to the front panel when the Display module’s *Show* input is pulsed.

The Display module’s setup registers determine screen type (e.g. numeric, event log, trend bar etc.), softkey name and number, and screen title of each display. Many Display modules available in the meter are used in the factory configuration. You can alter some characteristics of the factory-configured displays by modifying the setup register of the Display modules.

The Display module’s setup registers determine how the *Source* data is presented on the front panel display. Depending on the display screen type, which is specified by the *Screen Type* setup register, you can use up to twenty *Source* links to a single Display module. This means you can show the values of up to twenty different sources on one front panel display screen. In addition, you can display harmonics, trending, and event logs (see the Screen Types table below).

Setup Register	Function	Default
Screen Type	This specifies the way the linked parameters are displayed on the front panel screen.	Defaults vary among display screens.
Softkey Number	This assigns a softkey number to the display screen.	
Softkey Name	This assigns a softkey name to the display screen.	
Screen Title	This assigns a title to the display screen.	

Screen Types

Screen Types	Max. # of Source Inputs	Display Description
Two, three, four, eight, ten, and twenty parameter numeric ¹	2, 3, 4, 8, 10, and 20	Displays one to twenty values (the fewer the values, the larger the values appear on the display screen)
4 parameter trend bar graph ²	12	Displays 4 real time parameters with minimum and maximum values
Harmonics V1-V4	0	Displays phase voltage harmonics histogram
Harmonics I1 – I5	0	Displays phase current harmonics histogram
Vector diagram	0	Data is displayed in phasor format
Event Log	0	Displays Event Log data
Name plate	0	Displays Nameplate Information
All segments	0	Activates all of the display screen’s pixels
Data Log Trend - log source 1 to 4	4	Configures a Display module for Trend Display

- ¹ If you alter the *Screen Type* setting to a display type that accommodates more numeric parameters, you may have to create additional *Source* links.
- ² See “Creating Custom Trend Bar Graphs”.

Screen Type Register

The *Screen Type* setup register has five options: ONE PARAMETER, TWO PARAMETER, THREE PARAMETER, FOUR PARAMETER, AND DISABLED. The number of inputs for the Display module should match the *Screen Type* setup register.

If you select a *Screen Type* with more parameters than are currently linked to the Display module, the display screen will show any unavailable inputs as N/A. If a *Screen Type* is selected which has fewer parameters than are linked to the module, the Display module will only display the *Display Type* number, and will break any links to parameters that it cannot display.

For example, if you have a display screen with four parameters, and you select a *Screen Type* of ONE PARAMETER, the first parameter is displayed and the other three links to the ION Display module are severed.

Changing the Parameters that are Displayed

The meter’s default display configuration shows a comprehensive set of parameters. Changing these parameters requires that you alter the links between various ION modules. Complete details on configuring the front panel displays are provided in the section “Custom Front Panel Displays”.

Creating a Front Panel Reset

The meter’s factory configuration allows External Pulse module 6 to be triggered from the User Resets screen in the meter Setup menu. To define a custom reset, use ION software to link one of these External Pulse modules to the *Reset* input of the module that holds the value that you want to reset.

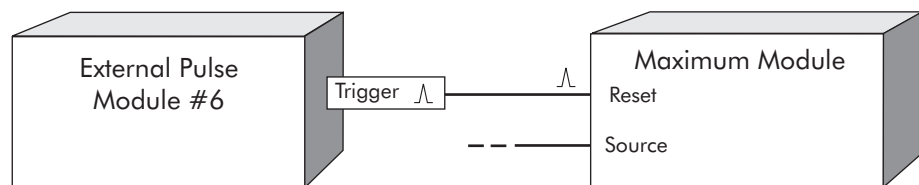

By default, the *Trigger* output of this module is linked to the User Resets item in the front panel Setup menu.

This ION module holds the value that you can reset from the front panel. You may also have to create and configure it.

Refer to the Resets chapter for more details about User Resets.

Accessing External Pulse module 6 in Designer

1. Open your meter in Designer.
2. Navigate to Advanced Configuration > Custom Resets. Edit External Pulse module 6 as required.

Custom Front Panel Displays

This section explains how to customize your meter’s front panel display screens using Designer software.

ION 7550 / ION 7650 meters ship with preconfigured display screens. Most users find that the data displayed by the front panel LCD (Liquid Crystal Display) suits their needs entirely. However, front panel displays may also be customized if required.

The meter’s display screens can be customized to show virtually any measurement or calculation of which the meter is capable. For example, you could do one or all of the following:

- ◆ change displayed parameters, such as from *Vll* to *Vln* or *Vllab* to *Vlna*
- ◆ aggregate displays from multiple meters, such as using a meter’s front panel display to view data collected by one or more TRAN units (see the section titled “Displaying Data from Other Meters”)
- ◆ adjust character size to be different on each screen
- ◆ change data display settings such as backlight timeout, automatic display scrolling, parameter update rate and display mode

In order to customize your front panel display screens, you must make changes to ION modules that belong to the display framework.

Display Framework Overview

The following diagrams illustrate how the Display Options module, Display module, and Scrolling module work together to provide your meter’s front panel with the appropriate display screens.

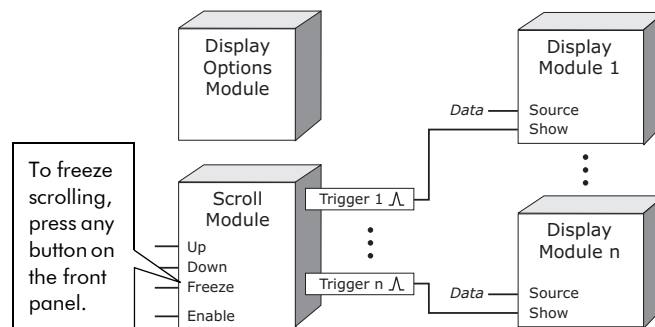

Note that the first Display module’s *Show* input is linked to the Scroll module’s first *Trigger* output register: this is your first display screen on the meter. Accordingly, the second Display module’s *Show* input is linked to the Scroll module’s second *Trigger* output in order to setup the second display screen, and so on.

The order in which data displays depends on the numbering of the Display modules. Therefore, the data linked to Display module 1 is displayed on the first front panel screen and so on. Scrolling between the display screens is done with the Up and Down arrow buttons on the front of the meter.

Accessing the Display Framework in Designer

1. Open your meter in Designer.
2. Navigate to Advanced Setup > Display Framework.

Changing Default Display Frameworks

The factory-configured Display framework uses many of the Display modules available in the meter. Only a few of the default screens have room for extra data. To make a significant modification to the existing display framework, you either have to create new display modules and configure them, or change the links and settings of the modules in the existing Display framework (or both).

Four common modifications are discussed in the following sections:

- ◆ removing a display screen
- ◆ adding a new display screen
- ◆ replacing the parameters in an existing display screen
- ◆ creating custom trend bar graphs

Removing a Display Screen

Use caution when deleting modules, as any dependant modules are also affected. Designer informs you of dependant modules if they exist on the same node.

Removing a data display screen in Designer

1. Select the Display module responsible for the screen.
2. Press Delete. This also deletes all links to that particular Display module.

If the display screen you are deleting is part of the automatic scrolling cycle, you should reconfigure the links from the Scroll module's *Trigger* outputs to the remaining Display modules so that the following considerations hold true:

- ◆ The first Display module in the scrolling cycle is linked to the *Trigger 1* output of the Scroll module.
- ◆ The last Display module in the scrolling cycle (module *n*) is linked to the *Trigger n* output of the Scroll module. For example, if your scrolling cycle consists of 5 screens, then *Trigger 5* should be linked to the fifth module in the cycle.
- ◆ The *Wraparound* setup register of the Scroll module designates the last trigger output (*Trigger n*). Expanding on the previous example, since *Trigger 5* is the last trigger, the Scroll module's *Wraparound* setup register would have a value of 5.

Adding a New Display Screen

You can create a new front panel display without dismantling any of the existing displays.

Adding a new display screen in Designer

1. Create a Display module.
2. Define the modules characteristics (display format) by adjusting its setup registers.
3. Link any required data to the *Source* inputs of the Display module.

If you want your new screen to appear in the automatic scrolling cycle, then you must link the *Show* input of the Display module to a *Trigger* output of a Scroll module. See “Removing a Display Screen” for considerations on re-linking Scroll module *Trigger* outputs.

Changing Displayed Parameters in an Existing Screen

Use Designer software to change displayed parameters in existing screens on your meter.

To change parameters, link the output register containing the numeric data you want to display to the *Source* inputs of the Display module. If there is not a free *Source* input, you will have to first delete (i.e., unlink) an existing link to a *Source* input.

Creating Custom Trend Bar Graphs

Bar Graph displays are configured differently than other numeric parameter displays. Each bar in the display is associated with three specific *Source* inputs as follows:

Bar Graph	Input	Function	Attributes
First (top)	Source 1	Real-Time value for Bar Graph #1	Bar graph #1 will not appear if you do not link this input
	Source 2	Minimum value for Bar Graph #1	Link to the output of a Minimum module
	Source 3	Maximum for Bar Graph #1	Link to the output of a Maximum module
Second	Source 4	Real-Time value for Bar Graph #2	Bar graph #2 will not appear if this input is not linked
	Source 5	Minimum for Bar Graph #2	Link to the output of a Minimum module
	Source 6	Maximum for Bar Graph #2	Link to the output of a Maximum module
Third	Source 7	Real-Time value for Bar Graph #3	Bar graph #3 will not appear if this input is not linked
	Source 8	Minimum for Bar Graph #3	Link to the output of a Minimum module
	Source 9	Maximum for Bar Graph #3	Link to the output of a Maximum module
Fourth (bottom)	Source 10	Real-Time value for Bar Graph #4	Bar graph #4 will not appear if this input is not linked
	Source 11	Minimum for Bar Graph #4	Link to the output of a Minimum module
	Source 12	Maximum for Bar Graph #4	Link to the output of a Maximum module

Typically, the minimum and maximum values for each bar graph come from links to the outputs of Minimum and Maximum ION modules that are themselves linked to the real-time parameter shown in the bar graph.

NOTE

This feature works only if the meter's Volts Mode is NOT set to Demo. When the meter is in Demo mode, a default trending log showing VII ab, Ia, PF and KW will be displayed rather than the actual log that has been linked to the Display module.

The diagram below shows an example of the links necessary for one bar graph (in the top position).

A bar graph reports a "Mn/Mx Display Error" in the following cases:

- ◆ Minimum input not linked
- ◆ Maximum input not linked
- ◆ Max input < Min input
- ◆ Min input > Max input

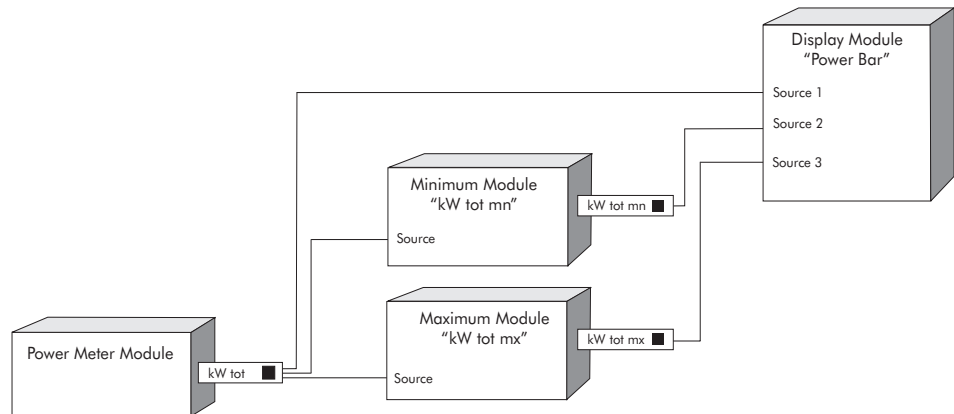

Trend Displays

Your meter's Trend Display screen simultaneously graphs the historical data of up to four different parameters. A Trend Display log screen displays the data logs for any graphed parameter.

The front panel displays three preconfigured trending screens: V-Trend (voltage), I-Trend (current), and P-Trend (power).

NOTE

It is possible to change the Trending parameters with Designer software. Contact Technical Support for information.

Trend Display Screen

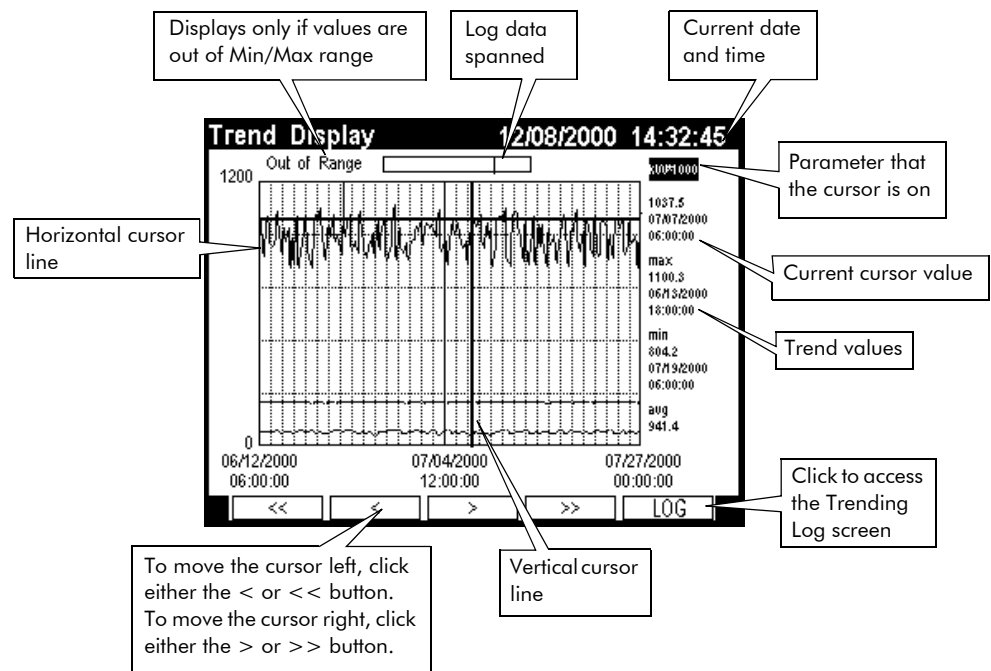

Selecting and navigating the Trend Display screen

- ◆ Press the appropriate softkey to view the Trend Display screen from the front panel.
- ◆ Once the trend is selected, the softkeys and Up/Down arrow keys only navigate within the Trend Display graph and log screens.

A moveable cursor, composed from the intersection of a vertical line and a horizontal line, displays the value and timestamp of any plotted data within a parameter. The cursor only displays the values of one parameter at one time. Move the cursor from one parameter to another with the Up and Down navigation keys.

- ◆ Use the ESC key to exit the Trend Display.

 **NOTE**

The default Trending parameters displayed are kW sd d-r, VII, and lavg. The minimum and maximum values of the graph automatically scale based on the Ct primary and Pt primary values.

Statistical values for the data (such as Minimum, Maximum, and Average) also display at the cursor location. The Minimum and Maximum values display with timestamps. Statistical values are calculated for all the historical data available in the associate data log, including the data that does not fit into the current screen view.

It is possible to display up to 3360 logs for each parameter; this is 35 days worth of 15 minute data. The graph is updated when a new set of values is recorded. The highest supported update speed is once per second.

By default, the data is logged for Trend Display every 15 minutes. Change this logging interval by configuring the Periodic Timer module's setup register with Designer software.

Changing the logging interval for Trend Display data

1. Open your meter in Designer.
2. Navigate to Advanced Configuration > Display Framework > Trending Display. The shortcut to the periodic timer module is labeled "Dsp Trnd Log Trg."
3. Right-click the Dsp Trnd Log Trg module setup register.
4. Double-click on the PT7 Period, and change the value.
5. Send & Save. The Trend Display screen now logs and plots data at the interval you specified.

 **NOTE**

Currently, the Trending Display screen only accepts synchronous data triggered by a periodic timer. If a setpoint module asynchronously triggers a data recorder which is set for the trending purposes, then it is possible that the records drawn in the screen will be unevenly distributed over time.

Trending Data Log Screen

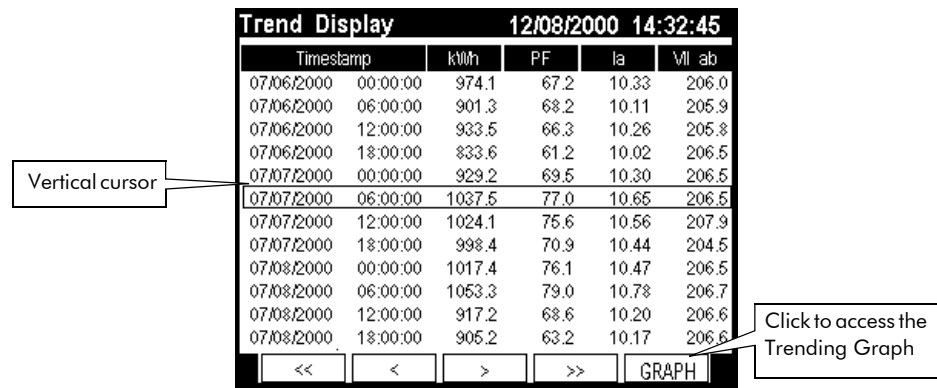

You can access a data log screen for any value on the graph. Simply press the softkey corresponding to the Log button to view the graphed value in a data log format. The log screen also lists the twelve parameter values that surround the current cursor position, each with a corresponding timestamp.

Screen Messages

Messages that may appear on the Trending Display screen are explained below.

Screen Message	Description
Start of Logged Data	This message displays when you have navigated to the extreme left of the Trending Display Graph where the plotted data starts.
End of Logged Data	When you have navigated to the extreme right of the Trending Display Graph where the plotted data ends, this message appears.
Out of Range	This displays when a logged data value is not within the minimum or maximum range. You can view the "out of range" values on the Data Log screen.
Setup Error	This never displays if you use the default Trending Display screens. This message will display if the default Trending Display framework has been modified so that a minimum value is larger than a maximum value. It also displays when a Display module configured for Trending has not been linked to a Data Recorder module, so there are no values to plot.
Invalid Log	This message displays whenever an invalid log value is recorded. In addition, trend graphs cannot be viewed.

Adding New Trend Display Modules

Users who are familiar with the ION architecture, Designer software, and Vista software can link additional Display modules for trending. Here are some guidelines:

- ◆ You can configure any Display module as Trend Display by setting the *Screen Type* setup register to *Data Log Trend - Log Source 1 to 4*.
- ◆ The maximum number of Trend Display modules permitted is 10.

- ◆ Any Data Recorder module output log can be connected to a Trend Display module.
 - ◆ The Data Recorder module output log must be connected to the first input of the associated Trend Display module.
 - ◆ Even though a Data Recorder module has up to sixteen Source inputs, only the first four Source inputs can be viewed in Trend Display.
- ◆ With External Numeric modules, min/max can be set in Vista.
 - ◆ The External Numeric module that sets up the minimum value for the displayed data must be connected to the second input of the associated Trend Display module.
 - ◆ The External Numeric module that sets up the maximum value for the displayed data must be connected to the third input of the associated Trend Display module.

Displaying Data from Other Meters

Data can be read at a workstation using ION Enterprise software, but there may be situations which require the data to be read at the source. With just one ION 7550 / ION 7650 meter, you can view the data collected by numerous TRANs and other devices over a serial network. This is done using the Modicon Modbus protocol. The ION 7550 / ION 7650 meter with the front panel display acts as the Modbus Master, while the other meters are the Modbus Slaves. The display meter has its protocol set to MODBUS MASTER, and each TRAN meter is configured to use the MODBUS protocol.

NOTE

A TRAN (transducer) meter is a basic meter model without a front panel display; a TRAN can be used with a remote display.

Refer to the *Modbus and ION Technology* technical note for more information on how to configure your meter as a Modbus Master.

Customized Display Framework

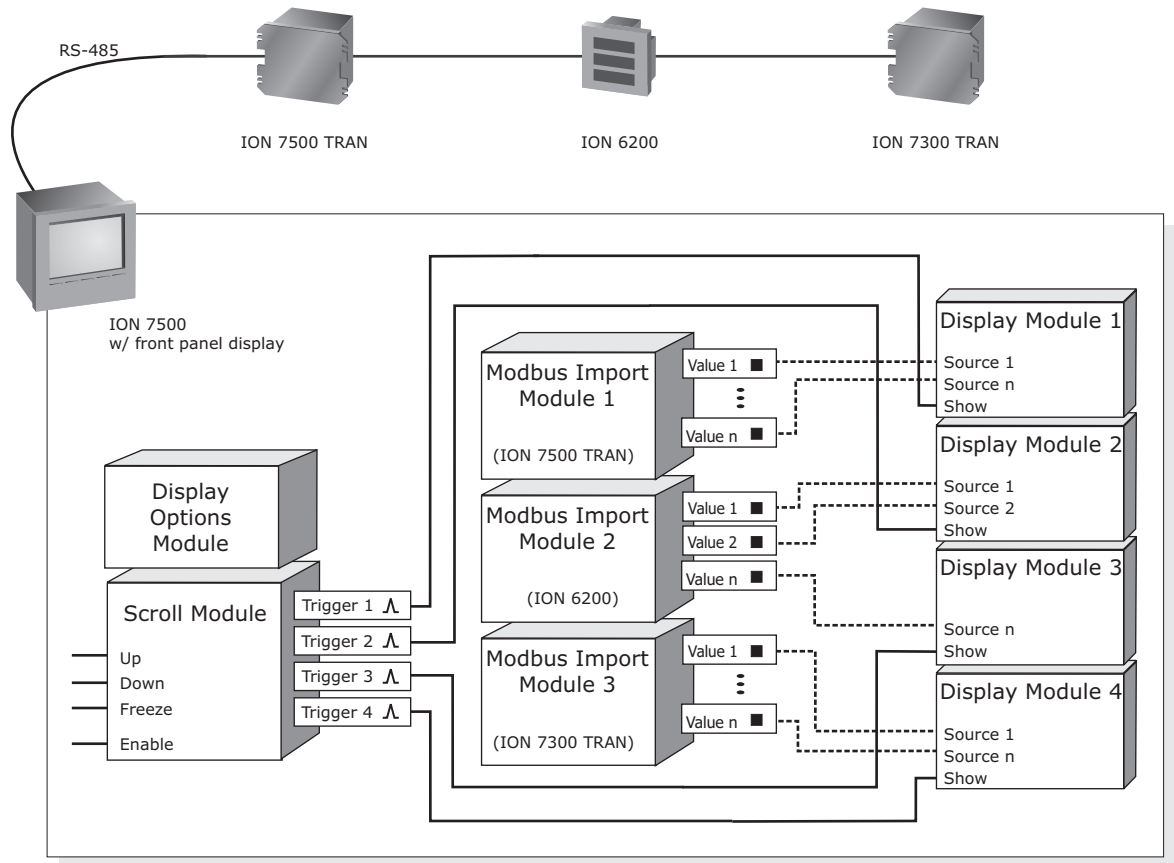

The ION 7550 meter with front panel display is the Modbus Master, showing data from the other meters (the Modbus Slaves) on the serial connection.

If this were the complete display framework, then there would be a total of four screens showing data on the ION 7550 with front panel display: one screen from each TRAN (the ION 7550 and the ION 7300) and two screens from the ION 6200. Notice how the ION 6200 has had its data displayed on different screens.

Configuring your custom display framework

To aggregate data from multiple devices on a network and display it on an ION 7550 / ION 7650 meter, follow the steps below. The framework changes are made to the meter displaying the data.

1. Launch Designer, ensuring that Options > Show Toolbox is checked.

If you want a blank work space, where you can keep your master configuration, simply drag out a new grouping object from the toolbox, name it appropriately and double-click on your new grouping object.
2. Drag out a Modbus Import module and right-click on the Modbus Import module to access the setup registers.
3. Use the *ReadNow* input of the Modbus Import module if you want to setup a trigger source that activates a read (i.e. a pulse). If you do not link *ReadNow* the module polls Modbus devices continuously.
4. Right-click the Modbus Import module to configure register settings.

Configure the following setup registers as needed: *Slave Address*, *Register Address*, *Number of Registers* read by the module, *Format* and scaling requirements. The supported *Slave Address* range (Unit ID on ION meters) for a Modbus device is from 1 to 247.

5. Repeat steps 2 - 4 for every meter or TRAN in the serial network whose data you wish to display on the meter with the front panel.

The meter with the front panel requires a separate Modbus Import module for each meter whose data it displays, because all meters in the network have unique Unit IDs. This is how the Modbus Master distinguishes which meter (*Slave Address*) is providing what data (*Register Address*).
6. Link each Modbus Import module's output registers to the appropriate Display module's *Source* inputs.
7. Define each Display module's characteristics (display format) by adjusting its setup registers. Do the same to the Display Options module if so desired.
8. See "Removing a Display Screen" for considerations on re-linking Scroll module *Trigger* outputs.

This step is important if you want to have your new screens appear in an automatic scrolling cycle, or if your custom framework has fewer display screens than the factory configuration, and you need to adjust the Scroll module's settings.

9. Send & Save changes.

chapter
3

Templates, Frameworks and Firmware

Your meter comes installed with a pre-configured default **template**. This template contains various **frameworks** which provide all the power measuring and analyzing functionality of the meter. Templates and frameworks can be used immediately without any user configuration (“right out of the box”). They can also be customized, reconfigured, and pasted from one meter to another.

For more information on templates, frameworks and ION modules, see the *ION Reference*.

Your meter’s operating system is known as **firmware**. When newer firmware is available for your meter, simply upgrade to the latest version for all the added features and functionality.

 **CAUTION**

ION 7500 / ION 7600 firmware is not compatible with ION 7550 / ION 7650 meters, and vice versa.

In This Chapter

◆ Factory Information	46
Factory Module Settings	46
How to TAG Your Meter	46
◆ Restoring the Factory Configuration	47
Using Designer	47
Using ION Setup	48
◆ Upgrading Your Meter	49

Factory Information

The Factory module displays firmware version, serial number and other device information in read-only setup registers (read-only registers can be viewed but not changed).

Factory Module Settings

The device information provided is as follows:

Setup Register	Description
Device Type	A device type identifier (e.g. "7650" for the ION 7650)
Compliance	A statement of whether the device is ION compliant or not
Options	Shows model number of meter
Revision	The meter's firmware version
Serial Num	The meter's serial number
ION Version	The ION version supported by the device
Template	The name of the template (framework) installed on the device at the factory
Nom Freq	The expected frequency of the power system being monitored

The Factory module also contains numerous read-only setup registers that hold the calibration constants used at the factory.

How to TAG Your Meter

Three configurable setup registers are provided for you to enter your company name and other text information you want stored in the meter:

- ◆ *Owner* - This is a text register for storing user information (e.g. company name); it can be up to 255 characters in length.
- ◆ *Tag 1* - This is a text register for storing user information (e.g. device location); it can be up to 15 characters in length.
- ◆ *Tag 2* - This is a text register for storing user information (e.g. device number or identifier); it can be up to 15 characters in length

Restoring the Factory Configuration

If you have made changes to the default functionality and want to return to the factory configuration, you can re-initialize the factory configuration in the meter using ION software. The basic setup of the device can be retained, so the meter does not need to be taken out of service for a long period of time.

NOTE

If you restore the factory configuration, all custom features you have created are lost.

Using Designer

1. Display the meter's main Configuration screen in Designer.
2. Choose Select All from the Edit menu, then press Delete.

The confirmation dialog box appears explaining that some modules will not be deleted (core modules cannot be deleted — scroll down in the dialog to see which standard modules will be deleted).

3. Click OK on the confirmation dialog box.

After a brief wait the modules are deleted, and the main meter Configuration screen is blank except for the Frameworks folder in the Advanced Setup area. (The Frameworks folder contains the folder of Core modules which cannot be deleted.)

4. Choose Select All from the Edit menu to select the Frameworks folder. This selects all subfolders and modules within the folder.
5. In the Edit menu, choose Paste from Framework, then select the appropriate .fwn file from the folder \ION Enterprise\config\fmwk\nd\. Click OK.

The Factory module's *Default Template* register tells you the filename for the default factory framework. (For details about framework files, contact Technical Support or visit the Support area of the Power Measurement web site.)

6. Click Open. The Paste Summary window appears.
7. Click on the first module, scroll down to the last module, hold the Shift key and click on the last module. This selects all of the modules.
8. While holding the Shift key, click on the check box to the left of the module name so you see a lock icon with a green check mark.

CAUTION

Persistent modules can be overwritten in Designer. When pasting a default framework onto a meter, use lock-paste on the Persistent modules, not free-paste. A list of Persistent modules is available from Technical Support.

9. Check "Maintain external inputs" and click OK on the confirmation dialog box.

A message appears indicating that Designer is pasting modules. All modules are selected when the paste is complete. Click anywhere in the background of the node diagram to deselect all of the modules.

10. Click the Power Meter shortcut in the Basic Configuration area to select it. Once selected, click Reset in the Designer toolbar, or select Reset from the Edit menu. This reverts the Power Meter to the settings it had before you deleted any modules (retaining the basic setup you previously had).
11. Choose Send & Save from the File menu. The factory configuration is now restored and any custom functionality you created is removed.

NOTE

The time required to complete steps 3, 5, and 11 may vary depending on your connection and the meter configuration.

Using ION Setup

1. Download your device's latest template from <http://www.pwr.com/support/downloads/>. Save the .DCF file in the .../ION Setup/TEMPLATE folder for easy access.
2. Connect to your meter in ION Setup, using Basic Mode.
3. Navigate to Setup Assistant > Template.
4. Click the Send to Meter tab and click the Send button.

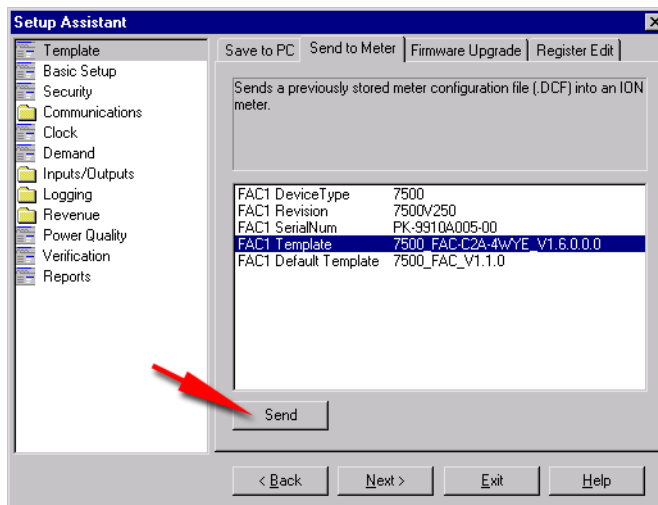

5. Select the .DCF file from the TEMPLATE folder and click OK.
6. The Template Paste Options screen appears. Select the check boxes for the settings you wish to retain (not overwrite) and click OK.

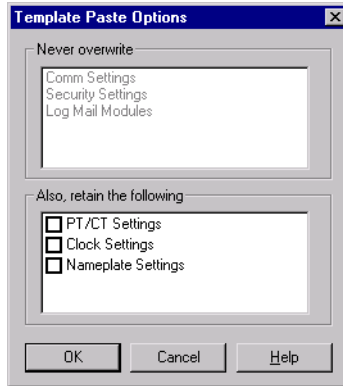

Rapid Meter Programming pastes the template onto your meter. A dialog box confirms the paste was successful.

Upgrading Your Meter

See the *Upgrading ION Device Firmware* technical note for details.



chapter
4

Basic Setup

This chapter explains how to perform basic meter setup.

In This Chapter

◆ Introduction	52
◆ Configuring Basic Setup	52
Using the Front Panel	52
Using ION Setup	53
Using Designer	53
Power Meter Module Settings	54

Introduction

Basic configuration of the meter is provided by the Power Meter module. The Power Meter module is the main connection between the power system measurements and all other ION modules in the device. This module reports the values for all voltage, current and power measurements. The Power Meter module's setup registers describe details of the power system being monitored. Many of the Power Meter module's setup registers are configured when the meter is initially put into service, although the device cannot operate properly until the Volts Mode and PT and CT ratios are set. Some registers may need to be changed to refine the device's operation. See the *ION Reference* for more details on the Power Meter module.

Configuring Basic Setup

Use the front panel or ION software to perform basic meter setup.

Using the Front Panel

The Basic Setup menu item provides access to the following power system settings:

Menu	Setting	Description	Range (Values)	Default
BASIC SETUP	VOLTS MODE	The power system's configuration – WYE, DELTA, etc.	4W-WYE, DELTA, 3W-WYE, SINGLE, DEMO	4W-WYE
	PT PRIMARY	The Potential Transformer's primary winding voltage rating	1 to 999,999.99	120.00
	PT SECONDARY	The Potential Transformer's secondary winding voltage rating	1 to 999,999.99	120.00
	CT PRIMARY	The Current Transformer's primary winding current rating	1 to 999,999.99	5.00
	CT SECONDARY	The Current Transformer's secondary winding current rating	1 to 999,999.99	5.00
	V4 PRIMARY	The Potential Transformer's primary winding voltage rating on V4	1 to 999,999.99	120.00
	V4 SECONDARY	The Potential Transformer's secondary winding voltage rating on V4	1 to 999,999.99	120.00
	I4 PRIMARY	The Current Transformer's primary winding current rating on I4	1 to 999,999.99	5.00
	I4 SECONDARY	The Current Transformer's secondary winding current rating on I4	1 to 999,999.99	5.00
	I5 PRIMARY	The Current Transformer's primary winding current rating on I5	1 to 999,999.99	5.00
	I5 SECONDARY	The Current Transformer's secondary winding current rating on I5	1 to 999,999.99	5.00
	Va POLARITY	The polarity of the Potential Transformer on Va	Normal or Inverted	Normal
	Vb POLARITY	The polarity of the Potential Transformer on Vb	Normal or Inverted	Normal
	Vc POLARITY	The polarity of the Potential Transformer on Vc	Normal or Inverted	Normal
	V4 POLARITY	The polarity of the Potential Transformer on V4	Normal or Inverted	Normal
	Ia POLARITY	The polarity of the Current Transformer on Ia	Normal or Inverted	Normal
	Ib POLARITY	The polarity of the Current Transformer on Ib	Normal or Inverted	Normal
	Ic POLARITY	The polarity of the Current Transformer on Ic	Normal or Inverted	Normal
	I4 POLARITY	The polarity of the Current Transformer on I4	Normal or Inverted	Normal
	I5 POLARITY	The polarity of the Current Transformer on I5	Normal or Inverted	Normal
CURRENT PROBE TYPE	The type of current probes being used with the meter	Factory Default, User Defined 1, or User Defined 2	Factory Default	

Using ION Setup

The Basic Setup Assistant helps you configure the Power Meter module.

1. Open ION Setup and connect to your meter, using Basic Mode.
2. In the Setup Assistant, navigate to Basic Setup and click on the PT/CT Ratios tab.

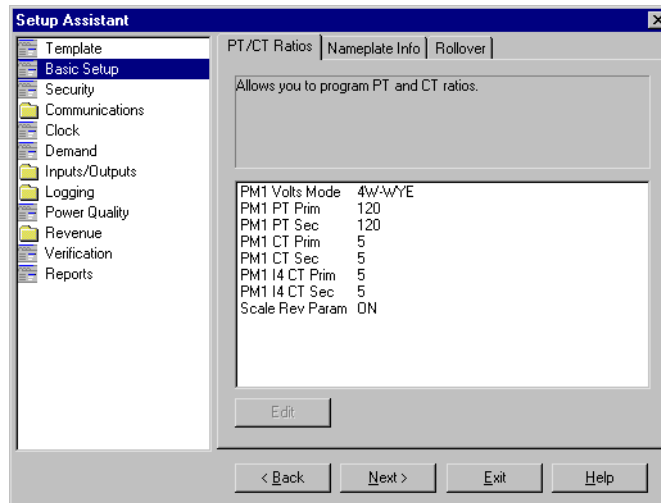

3. Configure each register as required by selecting the parameter and clicking Edit.

Using Designer

Open your meter in Designer and navigate to the Basic Configuration Framework. Right-click on the Power Meter module to edit.

Power Meter Module Settings

The Power Meter module contains the following setup registers:

Setup Register	Function	Default
Volts Mode ¹	The power system's configuration – WYE, DELTA, Single, etc	4W-WYE
PT Prim ¹	The Potential Transformer's primary winding rating for V1, V2 and V3	120
PT Sec ¹	The Potential Transformer's secondary winding rating for V1, V2 and V3	120
CT Prim ¹	The Current Transformer's primary winding rating for I1, I2 and I3	5
CT Sec ¹	The Current Transformer's secondary winding rating for I1, I2 and I3	5
V4 Prim ¹	The Potential Transformer's primary winding rating for V4	120
V4 Sec ¹	The Potential Transformer's secondary winding rating for V4	120
I4 CT Prim ¹	The Current Transformer's primary winding rating for I4	5
I4 CT Sec ¹	The Current Transformer's secondary winding rating for I4	5
I5 CT Prim ¹	The Current Transformer's primary winding rating for I5	5
I5 CT Sec ¹	The Current Transformer's secondary winding rating for I5	5
Vn Polarity	The polarity of the Potential Transformer on Vn	Normal
In Polarity	The polarity of the Current Transformer on In	Normal
Phase Order	The expected rotation of the voltage phases (ABC or ACB)	ABC
Phase Lbls	The phase label format assigned to the outputs (ABC, RST, XYZ, RYB, RWB or 123)	ABC

¹ The registers are typically set when the device is commissioned. Changing the values of these registers while the device is in service is not recommended.



chapter
5

Security

ION 7550 / ION 7650 meters offer Standard meter security, which is enabled from the factory. This chapter explains Standard meter security and how to change security settings using the front panel and ION software. It also details some security features available for revenue meters.

In This Chapter

◆ Meter Security Features	56
Standard Meter Security	56
◆ Configuring Meter Security	57
Using the Front Panel	57
Using Designer	58
Using ION Setup	60
◆ Device Security Access for ION Services	61
◆ Additional Revenue Metering Security	62

Meter Security Features

Your meter includes the following security features:

Standard meter security

Anytime you make configuration changes to your meter you must enter a password.

NOTE

Advanced Security is not available on ION 7550 / ION 7650 meters.

Anti-tamper sealing

Your revenue meter can be protected by anti-tamper sealing.

Software security

ION software security brings access-level security to the meter. With ION software, you can configure multiple users with different passwords and specify access rights. ION software security only applies to users who are accessing the meter via ION software.

For more information on meter security, refer to the *ION Security* technical note.

Standard Meter Security

Standard meter security lets you configure the meter through the front panel or with communications software using a meter password.

Standard meter security is enabled by default on all ION 7550 / ION 7650 meters; all configuration functions in the front panel are password-protected. The password is factory-set to 0 (zero).

If you make configuration changes to the meter via the front panel, the meter prompts you for its password before accepting any configuration changes. Similarly, if you make any configuration changes, via ION software or an internet browser, you are prompted by the meter for its password (in addition to the password used to access ION software). Once you enter the correct meter password and confirm the new configuration, the change is set on the meter.

Note that the front panel will prompt you for the meter password before you make your first configuration change. You will not need to re-enter the password for each subsequent change. However, if you perform no additional configuration changes for five minutes, you will need to re-enter the Setup menu and provide the valid meter password to resume making changes. This is because the meter returns from setup mode to data display mode after five minutes of inactivity.

Configuring Meter Security

Configure your meter's security settings through the front panel or with ION software.

Using the Front Panel

Use your meter's Security menu to:

- ◆ modify the existing meter password
- ◆ enable/disable the password security check
- ◆ enable/disable web browser configuration of the meter
- ◆ enable/disable the meter's web server

If have not yet entered your password, the meter front panel requires that you enter it before you can view the Security Setup menu.

NOTE

The password enables users to change the configuration of the meter. It is recommended that you change your password from the default when you put the meter into service.

If you enter an incorrect password, the front panel will display an "invalid password" message and you must try again.

Password

Use this setting to change the current password to any eight digit number. As with all configuration changes, you are required to confirm the change. By default, the password is set to 0 (zero) in the factory. The password may be changed to any eight digit number.

Changing the Meter Password using the Front Panel

1. Scroll down the Setup menu and select the Security Setup menu.
2. Press the PROG button to enter the Security Setup menu.
3. Press the MODIFY softkey. The menu selection Password becomes highlighted as well as the last zero.
 - ◆ To change the value of the highlighted digit use the Up/Down arrow buttons.
 - ◆ To change the position of the cursor one space to the left or right, use the Left/Right arrow buttons.
5. Press PROG to accept the new password.

Enabled

Use this setting to enable and disable password security on the meter. Disabling the password allows changes to all the meter's settings through the front panel without a security check.

Disabling (and enabling) password security using the Front Panel

Though it is not recommended, you can disable the meter password.

1. Scroll down the Setup menu and select the Security Setup menu.
2. Press the PROG button to enter the Security Setup menu.
3. Enter the current password and press PROG if you are presented with the Enter Password screen.
4. Press the softkey titled ENABLE, and select Yes to enable password security (if it has been disabled) or No to disable it.
5. Press PROG to make your selection. The Confirm screen appears.
6. Press PROG to confirm the change.

CAUTION

Non-secure access to critical settings in the meter, such as PT and CT ratios, is not advisable. It is highly recommended that any meter in the field have the password security check enabled.

When you re-enable password security, the password is reset to the factory default of 0 (zero). You should re-enter a custom password at this point.

Disabling the Password Security Check is required to write to the meter via the Modbus RTU protocol. Refer to the Third Party Protocols chapter for details about configuring your meter for third-party systems.

Web Config

Use this setting to disable web browser configuration of the meter. Default is Enabled.

Webserver Enabled

Use this setting to disable the webserver (WebMeter) functionality of the meter. Default is Disabled.

Using Designer

1. Launch Designer software with Supervisor access.
2. Select Options > Show Toolbox if the toolbox is not displayed.
3. From the Options menu, select Change Standard Meter Security...

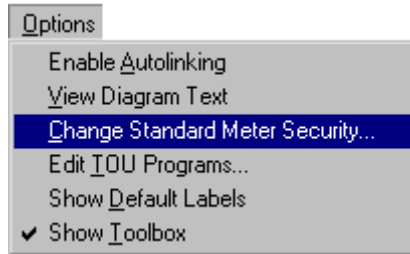

4. Enter the meter password when prompted. You must enter the existing meter password before you can change security settings (the default is zero).

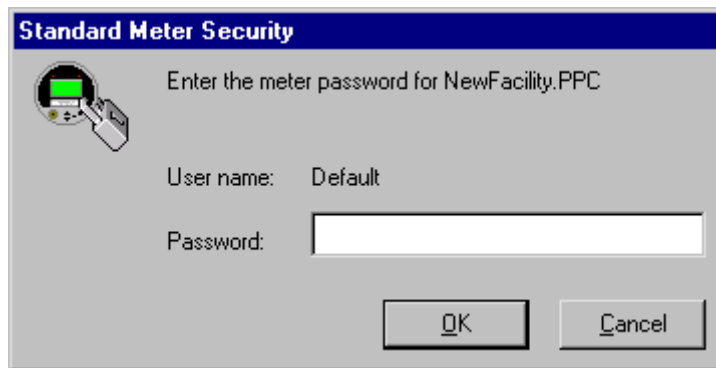

5. Type a new numeric password and confirm by re-typing the password in the fields (see image below). If you are sure you want to disable Standard security, click the Disable Standard Meter Security check box.

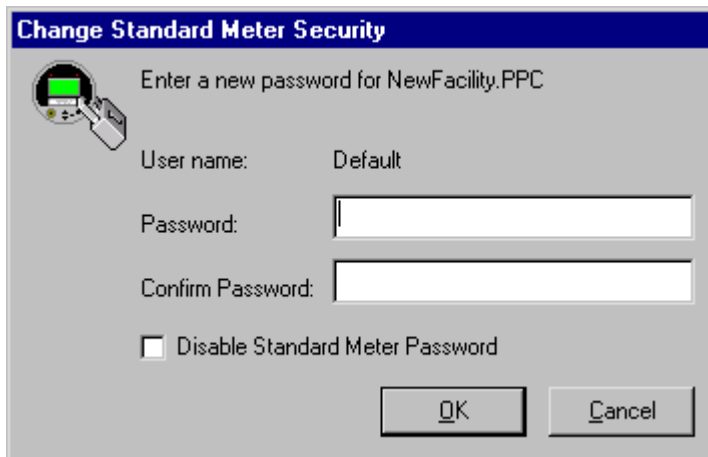

⚠ CAUTION

Do not disable security unless it is absolutely necessary. Disabling Standard security leaves your meter configuration open to tampering (intentional or unintentional) through communications and the front panel.

Using ION Setup

1. Launch ION Setup with Supervisor authority.
2. Connect to your meter, using Basic Mode.
3. In the Setup Assistant, navigate to Security.

The Security screen allows you to change the meter password and enable/disable webserver configuration.

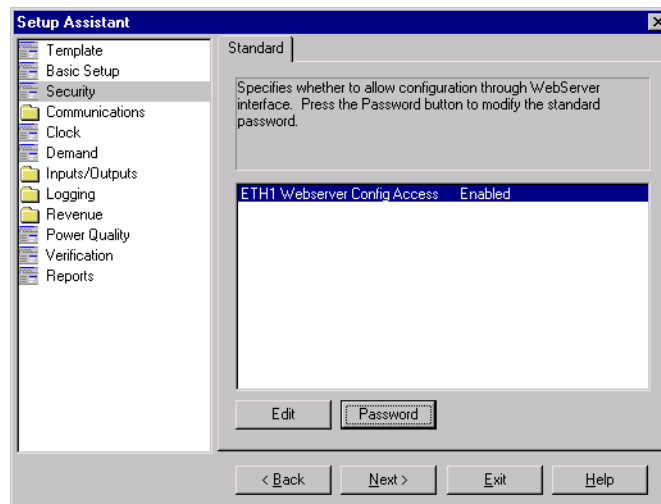

Changing the meter password

4. Click the Password button. The following dialog box appears:



5. Type a new numeric password and confirm by re-typing the password in the fields. Click OK.

Enabling/Disabling webserver configuration

6. Select the Webserver Config Access register and click Edit.

Device Security Access for ION Services

Many ION Services need constant access to your meter. These services include the ION Log Server, the Virtual Processor and Site Server that perform the following type of functions:

Service	Function
ION Log Server	Reads the ION meter Data Recorder or waveform modules and can automatically rearm recorders that are configured as Stop-When-Full
Virtual Processor	Can be configured to read from a meter or perform control action using Distributed Control.
Site Server	Broadcasts time signals to the meter.

NOTE

You may want to configure a separate user for accessing services. If you observe trouble with ION software accessing the meter, it is likely that these services either do not have access rights or the original user name and password have changed.

Allowing ION Services access to security enabled meters

1. Launch the Management Console and click Devices on the Management Console's System Setup Pane.
2. Highlight your meter, right-click and select Security... .
3. Select Standard Security from the drop down menu. Click the check box if you want to allow this user to send time synchronization signals to the meter. Click OK.
4. Enter the valid meter password for Standard Security, re-type the password to confirm, and click OK.

Additional Revenue Metering Security

To meet government regulations and utility security requirements, the revenue meter incorporates additional security systems:

- ◆ a hardware-locked security system that prevents modification of revenue quantities after the meter is sealed.
- ◆ a traditional anti-tamper mechanical seal on the meter base unit.

Hardware Lock Security Option

ION 7550 / ION 7650 meters offer a hardware-locked security feature. To make configuration changes on a hardware-locked meter, you must first place the meter in test mode. See the Test Mode chapter for more details.

Hardware Lock and Protected Values

The revenue-related settings on meters with the Hardware Lock option are factory configured and cannot be changed, even in test mode.

Typical values that are protected include:

- ◆ kWh, kVARh, kVAh delivered, received, del-rec, del+rec.
- ◆ kW, kVAR, kVA Thermal and Sliding Window demand min and max values.
- ◆ Digital Outputs controlling the energy pulsing applications.
- ◆ All Power system settings, including PT and CT ratios.

In certain countries revenue certification is void if the hardware lock is broken.

The Hardware Lock Option combined with Standard Security offers up the highest level of security.

Locked Module Listings

For a complete list of locked modules specific to your meter and firmware, contact Technical Support.

Anti-Tamper Seals

ION 7550 / ION 7650 revenue meters incorporate sealing tabs through which traditional lead/wire seals are inserted. These seals effectively prevent unauthorized personnel from gaining access to meter internals, and are provided with the meter.

For more information on ION 7550 / ION 7650 revenue meters see the *ION 7550 / ION 7650 Hardware Lockable Meter* product option document.



chapter
6

Communications

This chapter includes general instructions for connecting and configuring all the communication ports on your meter.

For specific installation steps and meter specifications, consult your Installation Guide.

In This Chapter

◆ Communications Overview	64
◆ Communications Connections	65
RS-232 Connections (COM1)	65
RS-485 Connections (COM1 and COM2)	66
Optical Port Connections (COM4)	68
Ethernet Connections (optional)	69
Internal Modem Connections (optional)	70
◆ Configuring Meter Communications	71
Serial Communications Setup	72
Ethernet Communications Setup	74
Modem Communications Setup	77
◆ Internet Connectivity	79
WebMeter Feature	79
ION MeterM@il Feature	79
WebReach	80
Telnet and HyperTerminal	80
◆ Communications LEDs	81

Communications Overview

The following illustration shows all the possible communications connections to the meter.

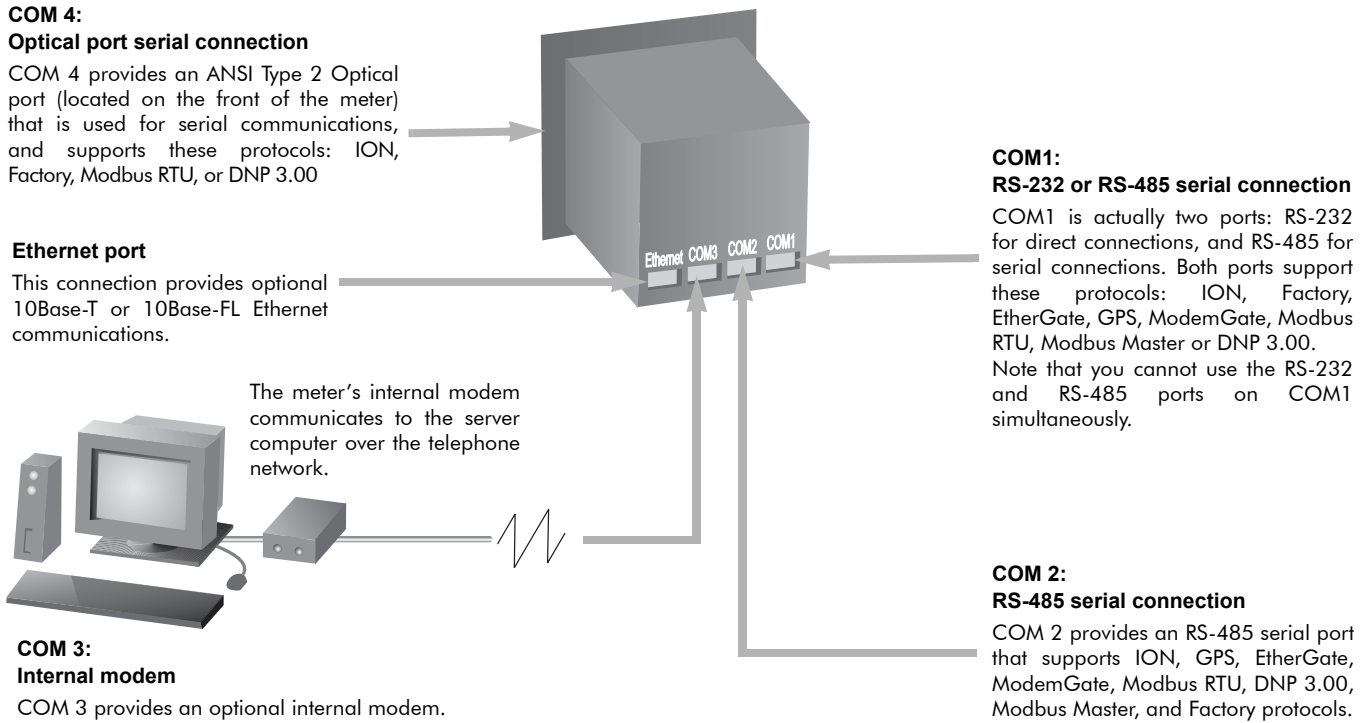

ION 7550 and ION 7650 meters have numerous communication possibilities depending on your ordering options. Both models have exactly the same communications options available.

All of the communication ports can be used concurrently.

COM Port	Available Connections	Standard/Option
1	Selectable RS-232/RS-485 port	Standard
2	Dedicated RS-485 port	Standard
3	Internal modem	Option
4	Optical port	Standard
Ethernet	10Base-T (or -FL) Ethernet ¹	Option

¹ 10Base-FL option will only be available if -FL was specified when the meter was ordered.

Communications Connections

The following section provides reference for connecting to the meter's various communication ports. For the most current communication specifications, see your meter's Installation Guide.

Most communications connections to the meter are made to the Communication Card, found on the **rear** of the meter. Optical connections are made to the port on the **front** of the meter. See below for details.

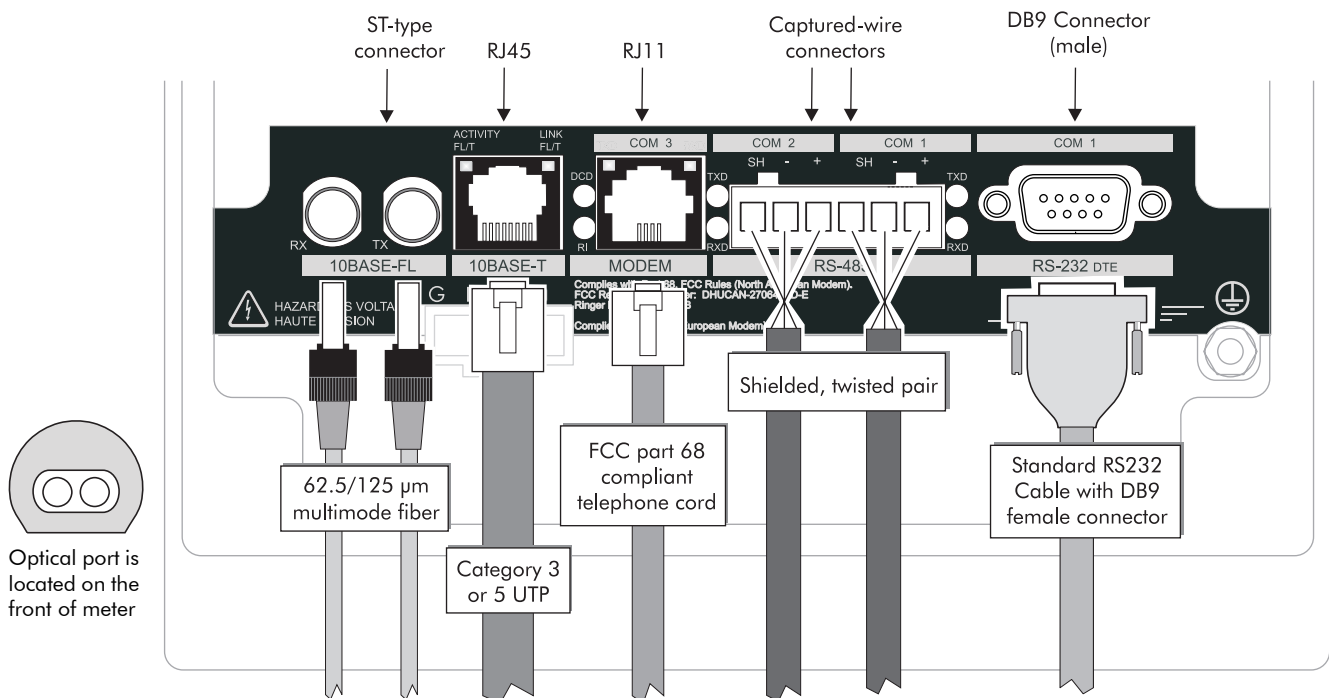

RS-232 Connections (COM1)

An RS-232 connection is made at the male DB9 connector (COM1) at the back of the meter. The meter acts as a DTE device in all RS-232 connections. Use a null modem cable for connecting a meter to a workstation or use a standard straight-through RS-232 cable for connecting to an external modem. In either case, one end of the cable must be equipped with DB9 female connector for mating with the DB9 male connector on the meter. The maximum cable length is 50 feet (15.2 m).

Computer Connections

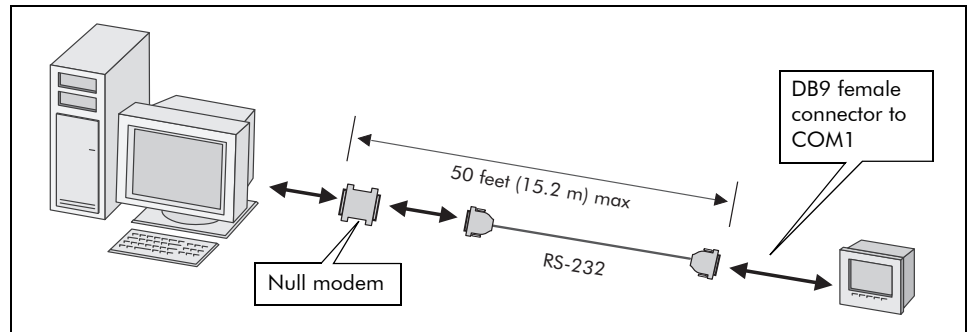

Meter Connections

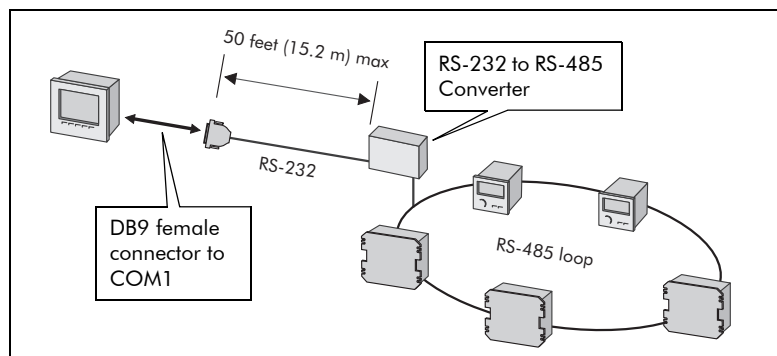

External Modem Connections

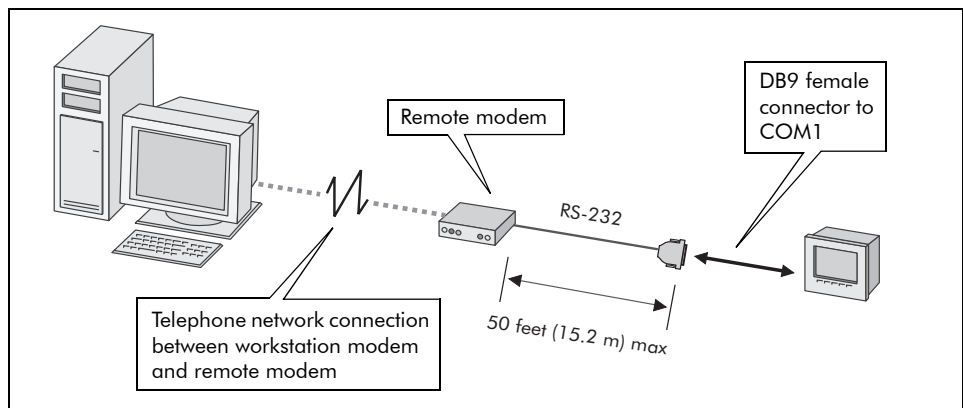

RS-485 Connections (COM1 and COM2)

RS-485 connections are made via the captured-wire connectors on the rear of the meter. Up to 32 devices can be connected on a single RS-485 bus. Use a good quality shielded twisted pair cable for each RS-485 bus. The overall length of the RS-485 cable connecting all devices cannot exceed 4000 ft. (1219 m). The RS-485 bus may be configured in straight-line or loop topologies.

Straight-Line Topology

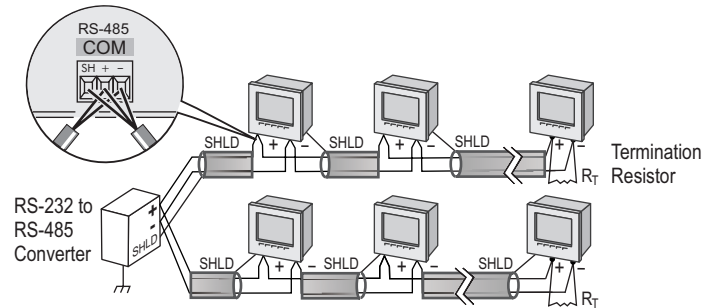

Loop Topology

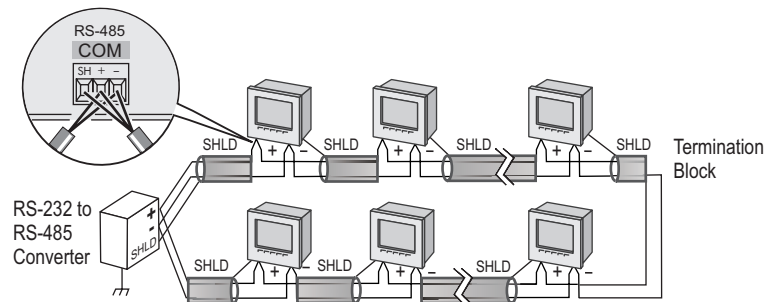

General Bus Wiring Considerations

Devices connected on the bus, including the meter, converter(s) and other instrumentation, must be wired as follows:

- ◆ Connect the shield of each segment of the cable to ground at *one end only*.
- ◆ Isolate cables as much as possible from sources of electrical noise.
- ◆ Use an intermediate terminal strip to connect each device to the bus. This allows for easy removal of a device for servicing if necessary.
- ◆ Install a ¼ Watt termination resistor (**RT**) between the (+) and (-) terminals of the device at each end point of a straight-line bus. The resistor should match the nominal impedance of the RS-485 cable (typically 120 ohms – consult the manufacturer's documentation for the cable's impedance value).

RS-485 Connection Methods to Avoid

Any device connection that causes a branch in the main RS-485 bus should be avoided. This includes *star* and *tee* (*T*) methods. These wiring methods cause signal reflections that may cause interference. At any connection point on the RS-485 bus, no more than two cables should be connected. This includes connection points on instruments, converters, and terminal strips. Following this guideline ensures that both star and tee connections are avoided.

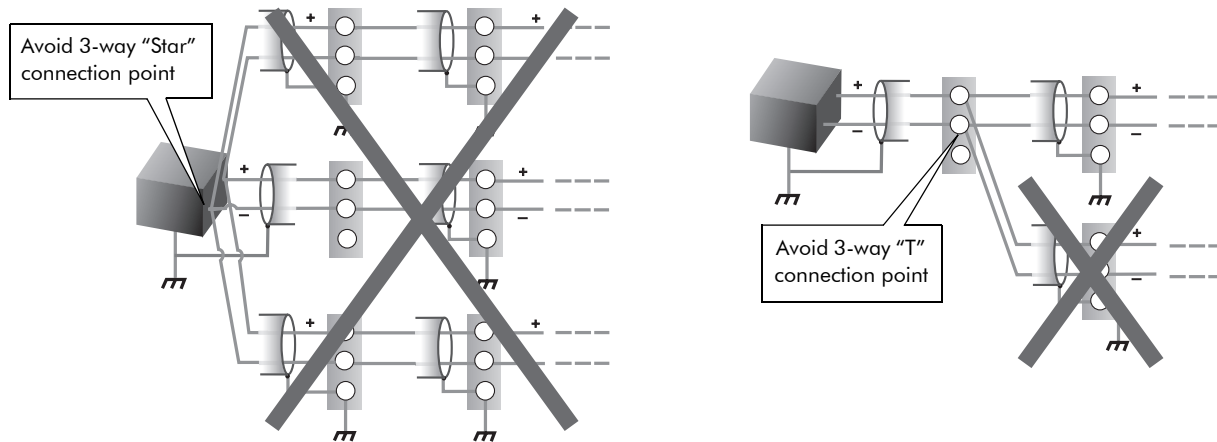

Optical Port Connections (COM4)

The front optical port is designed to accept ANSI Type 2 magnetic couplers. It can be used to communicate real-time measurements to a portable PC, or for meter configuration, via the ION, Factory, Modbus RTU, or DNP 3.00 protocols.

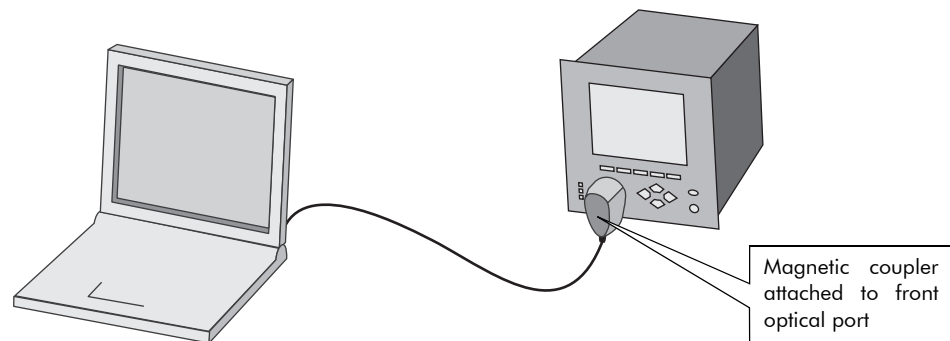

To enable communications from the optical port, configure the Comm 4 Communications module. The *Protocol*, the *Baud Rate* and *Unit ID* setup registers must properly match your system. When creating an ION site, ensure that *RtsCts* is disabled (set to No) in the COM4 serial site.

Refer to the Management Console section in the online *ION Enterprise Help* for more details about adding serial sites.

Ethernet Connections (optional)

This section only applies if your ION 7550 or ION 7650 meter has the Ethernet option.

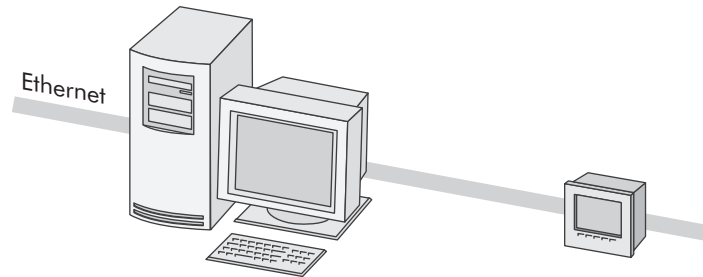

There are two Ethernet port ordering options available: a 10 Base-T port with an RJ45 modular connector or a 10 Base-FL port with two ST-type connectors. Both types of connectors plug into the Communications Card ports on the back of the meter. The meter supports a maximum of four simultaneous Ethernet connections.

The optional Ethernet port:

- ◆ is capable of data rates up to 10Mbps
- ◆ supports TCP/IP, ION, Telnet, DNP 3.0 and Modbus/TCP protocols
- ◆ is controlled by the ETH1 Communications module.

NOTE

Using the -FL option disables the standard RJ45 port.

The EtherGate feature provides communications both to an Ethernet connected device and through that device to a connected serial network (See the section “The EtherGate Protocol”). Only one EtherGate connection is allowed per meter port at any given time.

Internal Modem Connections (optional)

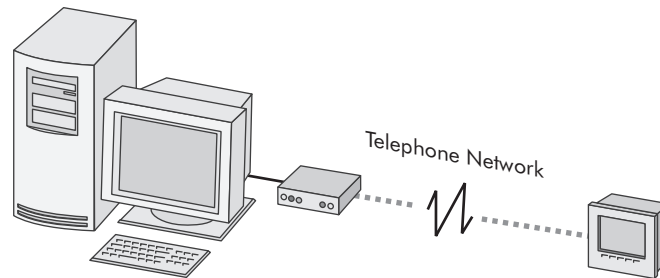

The meter's optional internal modem is manufactured by Multi-Tech. This universal modem can be readily used in most countries, and complies with FCC, Industry Canada and TBR-21 regulations — refer to the Notices at the start of this document for more details.

Modem connections are made to the Communication Card on the back of the meter, via an RJ11 connector.

To enable communications through the meter's internal modem, you must configure the Comm 3 Communications module. The *Baud Rate*, *Unit ID*, and *Protocol* setup registers must properly match your system, and the initialization string for the internal modem must be set up using the *ModemInit* register. See the section "Modem Communications Setup" for details.

Configuring Meter Communications

Communication settings are typically configured when the ION meter is initially put into service. A single Communications module controls each communications port on the meter. The modules' setup registers define the parameters used for each port; these parameters vary according to the type of communications channel selected (i.e. RS-232, RS-485, Modem, Optical, Ethernet).

The Communication modules control the following channels:

Module Name	Settings
Comm 1	Selectable RS-232 or RS-485 port on COM1
Comm 2	High-speed RS-485 port on COM2
Comm 3	Optional internal modem on COM3
Comm 4	Optical port on COM4
Ethernet	Optional 10Base-T or 10Base-FL Ethernet port

Use the meter's Front Panel or ION Setup to initially configure the meter's communications. Once communication is established, Vista or Designer may also be used to make changes.

NOTE

Altering some settings of a communications channel that is in use causes a loss of communications with the meter.

Refer to the Communications module description in the *ION Reference* for complete details about all the setup registers in the Communications module.

Communications Protocols

By default, all communication ports are configured to use the ION protocol. To use of other protocols requires configuration of the *Protocol* setup register for the Communications module that controls the port you want to use. Not all protocols are available on all ports.

Available Protocols

- ◆ ION
- ◆ Modbus RTU
- ◆ Modbus Master
- ◆ DNP 3.0
- ◆ GPS
- ◆ EtherGate
- ◆ ModemGate
- ◆ Factory (reserved for use by Technical Support)

Serial Communications Setup

Serial communications are available on COM1, COM2, COM3 and COM4. To enable communications through the meter's serial ports, configure the applicable Communications module. The *Protocol*, *Tran Delay*, *Baud Rate* and *Unit ID* setup registers must properly match your system and can be set through the meter's front panel or ION software.

Using the Front Panel

The current configuration of the meter's communication ports are found in the various COM Setup menu items. Ethernet settings are located under Network Setup.

Menu	Setting	Description	Range (Values)	Default
COM1 SETUP	PROTOCOL	The communications protocol	ION, Modbus RTU, Modbus Master, DNP V3.00, GPS:Truetime/Datum,GPS: Arbiter, GPS:Arbiter-Vorne, Factory, Ethergate, ModemGate	ION
	BAUD RATE	The data rate, in bits per second	300 ¹ , 1200, 2400, 4800, 9600, 19200, 38400, 57600, 115200	9600
	TRAN DELAY	The transmit delay in seconds	0 to 1	0.010
	UNIT ID	Every meter on an RS-485 network must have a unique Unit ID number	1 to 9999	From serial number ²
	MODE	Hardware mode for port	RS232 or RS485	RS232
	FLOW CONTROL	Specifies the handshake mode when COM1 is set to RS232	RTS + DELAY or RTS/CTS	RTS + DELAY
COM2 SETUP	PROTOCOL	The communications protocol	ION, Modbus RTU, Modbus Master, DNP V3.00, GPS:Truetime/Datum,GPS: Arbiter, GPS:Arbiter-Vorne, Factory, Ethergate, ModemGate	ION
	BAUD RATE	The data rate, in bits per second	300 ¹ , 1200, 2400, 4800, 9600, 19200, 38400, 57600, 115200	9600
	TRAN DELAY	The transmit delay in seconds	0 to 1	0.010
	UNIT ID	Every meter on an RS-485 network must have a unique Unit ID number	1 to 9999	101
COM3 SETUP	PROTOCOL	The communications protocol	ION, Modbus RTU, Modbus Master, DNP V3.00, GPS:Truetime/Datum,GPS: Arbiter, GPS:Arbiter-Vorne, Factory	ION
	BAUD RATE	The data rate, in bits per second	300 ¹ , 1200, 2400, 4800, 9600, 19200, 38400, 57600, 115200	9600
	TRAN DELAY	The transmit delay in seconds	0 to 1	0.010
	UNIT ID	Every meter on an RS-485 network must have a unique Unit ID number	1 to 9999	102
	ANSWER HR RINGS	The number of rings during defined answer hours	0 to 255	1
	NON-ANSWER HR RINGS	The number of rings during defined non-answer hours	0 to 255	5
COM4 SETUP	PROTOCOL	The communications protocol	ION, Modbus RTU, DNP V3.00, Factory	ION
	BAUD RATE	The data rate, in bits per second	1200, 2400, 4800, 9600, 19200, 38400, 57600, 115200	9600
	TRAN DELAY	The transmit delay in seconds	0 to 1	0.010
	UNIT ID	Every meter on an RS-485 network must have a unique Unit ID number	1 to 9999	102

¹ 300 baud rate is only intended for paging applications.

- 2 The factory set Unit ID for COM1 is based on the serial number of the meter, using the last four numbers before the dash. For example, if the serial number is PA-0009B263-01, the Unit ID is set in the factory to 9263. After a factory reset, the unit ID number will default to 100.

Using ION Setup

1. Open ION Setup and connect to your meter, using Basic Mode.
2. In the Setup Assistant, navigate to the Communications folder.
3. Click on the Serial Settings folder to configure serial communications.

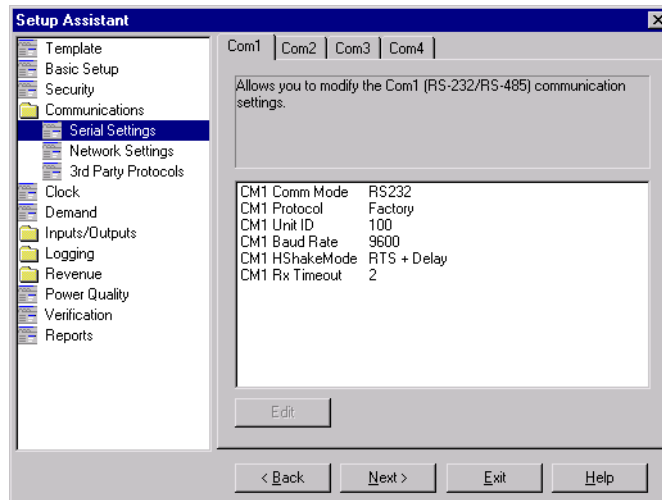

4. Click on the various tabs to configure the four serial ports (Com1, Com2, Com3 and Com4). To change a setting, select the parameter and click the Edit button.

Using Designer

Use Designer to enable serial communications on a meter port by configuring the associated Communications module.

1. Open your meter in Designer. Navigate to the Communications Setup framework.
2. Right-click the Communications module and configure the *Protocol*, *Tran Delay*, *Baud Rate* and *Unit ID* setup registers to match your system.

Ethernet Communications Setup

To enable communications through the meter's Ethernet port, configure the Ethernet Communications module. The *IP Address*, *Subnet Mask*, *Gateway*, *SMTP Server* and *SMTP Connection Timeout* setup registers must properly match your system and can be set through the meter's front panel or ION software.

Using the Front Panel

The current configuration of the meter's communication ports are found in the various COM Setup menu items. Ethernet settings are located under Network Setup.

Menu	Setting	Description	Range (Values)
NETWORK SETUP	IP ADDRESS	Sets the IP address for the meter	000.000.000.000 to 999.999.999.999
	SUBNET MASK	Used if subnetting applies to your network	000.000.000.000 to 999.999.999.999
	GATEWAY	Used in multiple network configurations	000.000.000.000 to 999.999.999.999
	DNS PRIMARY	Sets the address for the primary DNS Server that is configured to resolve domain names	000.000.000.000 to 999.999.999.999
	DNS SECONDARY	Sets the address for the secondary DNS Server that is configured to resolve domain names	000.000.000.000 to 999.999.999.999

Use the four front panel Navigation buttons to edit the values of the network settings so that they match your system addresses.

As you configure the network addresses, the front panel automatically hides unnecessary leading zeroes from each three-digit grouping. The hidden leading zeroes appear (and disappear again) as you move the position of cursor across the network address.

89.123.40.056

In the example above, the highlighted zero is hidden as soon as you change the position of the cursor.

Using ION Setup

1. Open ION Setup and connect to your meter, using Basic Mode.
2. In the Setup Assistant, navigate to the Communications folder.
3. Click on the Network Settings folder to configure Ethernet communications.

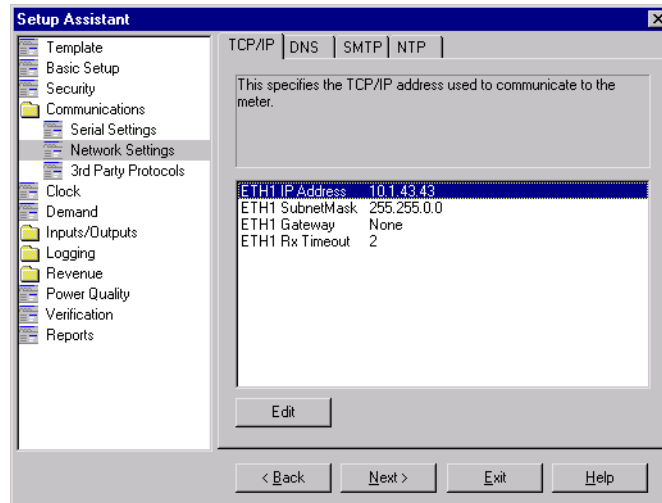

4. Click on the various tabs to configure the meter's TCP/IP, DNS, NTP and SMTP settings. To change a setting, select the parameter and click the Edit button.

Using Designer

1. Open your meter in Designer.
2. Navigate to the Communications Setup framework.
3. Right-click the Ethernet Communications module and configure the *IP Address*, *Subnet Mask*, and *Gateway* setup registers to match your system.

Meter Network Configuration and ION Enterprise

After you have wired your meter to the Ethernet network and performed basic setup, add the meter to your ION Enterprise network using the Management Console.

See the Management Console section in the online *ION Enterprise Help* for details.

The EtherGate Protocol

The EtherGate protocol is a communications tool that lets you communicate **to** a meter and **through** a meter simultaneously. When a meter installed on the Ethernet network has EtherGate enabled, a master device (such as a workstation running ION Enterprise software) can communicate to the meter, and through the meter to a serial network of devices wired to the meter's COM port. EtherGate is available on serial ports COM1 and COM 2. The protocol permits the direct transfer of data from up to 62 devices (31 devices per COM port).

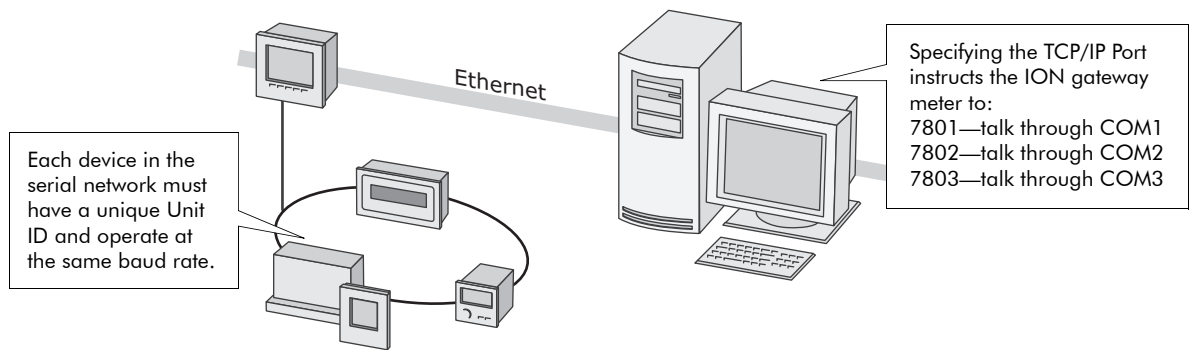

Once you have the chain of serial devices installed, use ION Setup or the meter's front panel to change the COM1 or COM2 Protocol setting to EtherGate. The transfer of data between protocols is then handled automatically.

Refer to the *ION Meter as an Ethernet Gateway* technical note for complete details on configuring your meter for EtherGate.

Modem Communications Setup

See the section “Serial Communications Setup” for configuring COM3. Additional modem configuration required is explained in the following section.

ModemInit Setup Register

The *ModemInit* string register defines the initialization string for the internal modem, with a maximum of 47 characters. Edit the *ModemInit* register and enter the initialization string desired. The string is sent to the modem as soon as you download the COM1 module. Note that the string is also sent to the modem whenever the meter is powered up, or whenever the baud rate in the Comm 1 Communications module is changed. Any changes to the *Modem Init* or *Baud Rate* setup registers while the modem is online will cause the modem to disconnect from the phone line.

Modem Initialization Strings

Refer to the technical note *Modem AT Commands* for a complete list of AT commands for your modem.

Adjusting the Modem Initialization String for CTR-21 Compliant modems

The table below shows the strings to add to the end of your modem configuration string setup register for each of three possible problems.

Problem	Add to Modem Initialization String
Does not answer (modem does not detect ring tone)	*NC70
Does not dial (modem does not detect dial tone)	In order of preference: *NC70, *NC70X0, *NC8 (Italy only)
Does not detect busy signal	*NC70

If your **local** modem (not the internal modem) is not already set up, configure it with the Remote Modem Configuration Utility according to the instructions in the online help. After the meter is installed and the internal modem is connected to the telephone network, the Comm 3 module can be configured using the meter’s front panel or ION software. To learn how to connect the internal modem to the telephone network, consult your meter’s Installation Guide.

Adding a Meter and a Modem Site to your ION Enterprise Network

In the Management Console, add the meter with the internal modem, and a modem site to your ION Enterprise network.

Consult the online *ION Enterprise Help* for details on commissioning an ION network, managing modem connections, setting up periodic dial-out, and configuring remote site event notification.

The ModemGate Protocol

The ModemGate feature creates a communications connection between the telephone network and an RS-485 serial network of devices. When you specify the protocol for a meter's COM port as MODEMGATE, all data received by the meter's internal modem is automatically transferred to the serial network. ModemGate is available on either COM1 and COM2, but you cannot use the protocol on both ports simultaneously.

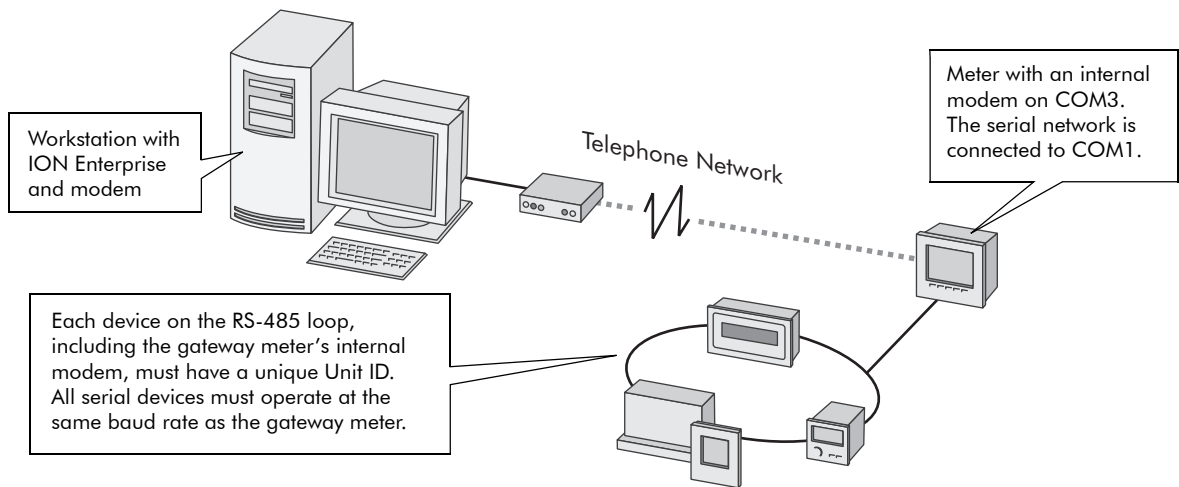

ModemGate connections do not connect a workstation with ION Enterprise (or other master device) to the gateway meter's COM1 or COM2 port, but rather the gateway meter's internal modem port (COM3).

Refer to the *ION Meter as a ModemGate* technical note for complete details on configuring your meter for ModemGate.

Internet Connectivity

Ethernet ION 7550 / ION 7650 meters provide Internet connectivity so you can receive meter emails, view real-time data, and configure your system through a web browser from anywhere in the world. Your meter provides the following internet connectivity options:

- ◆ MeterM@il® feature (receive data logs and email alerts from the meter)
- ◆ WebMeter® feature (onboard web server allows you to view real-time data and configure the meter through a web browser)
- ◆ Microsoft Terminal Services for ION Enterprise (an ION Enterprise system that is located on a Terminal Server allows multiple users to view or configure an ION Enterprise system through a web browser)
- ◆ WebReach (view ION Enterprise system information through a web browser)

WebMeter Feature

WebMeter-enabled meters have an on-board web server. Built-in web pages display certain energy and basic power quality information and also support basic meter configuration tasks. A meter with the WebMeter feature can be connected to your corporate Ethernet network like any other network device, and you can access it with a standard web browser like Internet Explorer.

Refer to the technical note *WebMeter Internal Web Server Feature* to learn how to:

- ◆ view your WebMeter data on the Internet
- ◆ configure your WebMeter-enabled meter
- ◆ set up your network for the WebMeter feature
- ◆ enable/disable web browser configuration of the meter

ION MeterM@il Feature

The MeterM@il feature allows your meter to send data logs as email attachments to a workstation, pager, cell phone, or PDA. In addition to the log export function, your meter can send email alerts.

Refer to the technical note *ION MeterM@il Internal Email Client Feature* to learn how to:

- ◆ view MeterM@il data
- ◆ set up your network for the MeterM@il feature
- ◆ configure your meter to use the MeterM@il feature
 - ◆ set up the meter for your SMTP Server
 - ◆ set up the MeterM@il feature to send alerts
 - ◆ set up the MeterM@il feature to send data logs

WebReach

WebReach allows you to remotely view ION Enterprise information through a web browser. WebReach requires a simple URL and no client machine configuration so you have the flexibility to view your data from a web browser anywhere in the world. With WebReach, you can view real-time data and select views of historical/waveform data. Currently, no configuration or control functions are available through WebReach. Refer to the online *ION Enterprise Help* for more details on WebReach.

Telnet and HyperTerminal

You can access certain Ethernet settings and statistics through a telnet application such as Microsoft Telnet. Similarly, you can use Windows HyperTerminal to access certain meter module settings. Use the following guidelines to determine which application you should use to access your meter:

- ◆ If your meter is connected to an Ethernet network, use a telnet application such as Microsoft Telnet.
- ◆ If your meter is connected serially or through a modem to your workstation, use a terminal application such as Windows HyperTerminal.

You can access certain Power Meter module and Factory module settings from both a Telnet session and HyperTerminal session. Both sessions also let you configure Factory module setup registers for Current Probe Input applications. Additionally, a Telnet session lets you view ethernet statistics and access certain Ethernet communications module settings.

Refer to the technical note *Telnet and HyperTerminal Access* for the appropriate application's menu options and connection instructions.

Communications LEDs

The following table explains what the flashing LED lights on the back of the meter signify.

LED	Color	Function
Ethernet ACTIVITY	Red ¹	Flashes as signals are transmitted and received for both Ethernet 10 Base-T and 10 Base-FL ports
Ethernet LINK	Green ¹	On as long as there is an active connection to either the 10 Base-T or 10 Base-FL ports
Internal Modem DCD	Green	Carrier Detect– Indicates the presence of a carrier signal (active connection to the modem)
Internal Modem RI	Green	Flashes to when the modem detects rings (Ring Indicator)
COM3 TRANSMIT	Red	Flashes as signals are transmitted from the COM3 internal modem
COM3 RECEIVE	Red	Flashes as signals are received on COM3 internal modem
COM2 TRANSMIT	Red	Flashes as signals are transmitted from the COM2 RS-485 loop
COM2 RECEIVE	Red	Flashes as signals are received on COM2 RS-485 loop
COM1 TRANSMIT	Red	Flashes as signals are transmitted from the COM1 RS-232 connection or the COM1 RS-485 loop
COM1 RECEIVE	Red	Flashes as signals are received on COM1 RS-232 connection or the COM1 RS-485 loop

¹ One or both of the Ethernet LED colors may differ from the standard red and green.



chapter
7

Third-party Protocols

This chapter explains how Modbus and DNP 3.0 protocols are implemented on the meter.

In This Chapter

◆ Overview	84
Communications Protocol Configuration	84
◆ The Meter as Modbus Slave	85
Using the Modbus RTU Protocol	85
Modbus Slave Modules	86
Using the Modbus/TCP Protocol	101
◆ The Meter as Modbus Master	102
◆ Configuring Modbus	103
◆ Using the DNP 3.0 Protocol	105
Configuring DNP 3.0	105

Overview

ION 7550 / ION 7650 meters support DNP 3.0, Modbus RTU and Modbus/TCP protocols.

While your meter is factory configured to **send** data (acting as Modbus Slave), it is not ready to **receive** data as a Modbus Master until you set up the necessary framework. The meter is also pre-configured to **send** DNP 3.0 data to a DNP Master.

 **NOTE**

Changing the default factory third-party protocol frameworks (or creating new frameworks to enable receive functionality) is an advanced procedure. Refer to the DNP modules and Modbus modules descriptions in the *ION Reference*, as well as the technical notes *Multiprotocol DNP 3.0 and ION Technology*, and *Modbus and ION Technology* before proceeding.

Most Modbus and DNP modules on the meter are factory pre-set and only require basic configuration, such as communications setup.

 **NOTE**

Changing these modules from their factory configuration is an advanced setup procedure that requires an understanding of the protocol, as well as an understanding of the meter's internal operation. For more information on your meter and these protocols see the *Common Modbus Registers* document and the *ION 7550 / ION 7650 DNP 3.0 Device Profile*.

Communications Protocol Configuration

In order to use the factory Modbus or DNP configuration, you must first assign the communications channel you want to use. By default, all communications ports are configured to use the ION protocol. Choose the 3rd-party protocol you want from the list of available protocols in the Communications module's Protocol setup register. See the Communications chapter for instructions.

 **NOTE**

Modbus RTU is available on each of the meter's communications ports, and multiple ports can communicate using Modbus simultaneously. Up to three ports can use the DNP 3.00 protocol at any one time.

The Meter as Modbus Slave

Your meter can act as a Modbus Slave, using both the Modbus RTU and Modbus/TCP protocols.

Using the Modbus RTU Protocol

Both the ION 7550 and ION 7650 meters can act as Modbus Slave devices, making any real-time data available through the Modicon Modbus RTU protocol. Modbus Master devices connected to the meter can access (read) this data or write data to your meter's ION registers, making device configuration changes and initiating control actions.

The Factory Modbus Slave Configuration

The meter makes data available to Modbus Master devices using pre-configured Modbus Slave modules. These modules are linked to other modules in the meter that provide the energy, power and demand data. Once a communications channel is configured to use Modbus RTU protocol, the data is available to Modbus Master devices.

NOTE

Connect to IP Service Port 7701 for Modbus RTU communications over Ethernet. The Modbus Unit ID of the meter over Ethernet is 100.

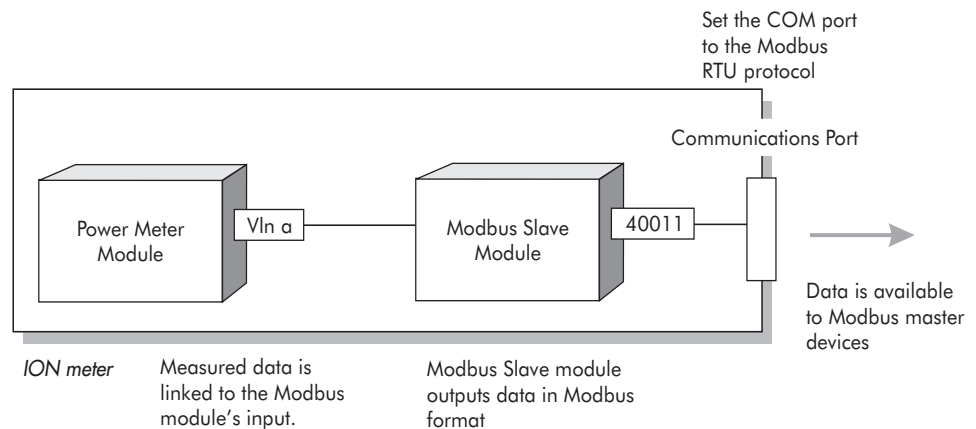

As the data available through the Modbus Slave modules is in a specific format, knowledge of the Modbus protocol and an understanding of the settings used in the meter are required to interpret the data provided.

Changing the Modbus Configuration

If the factory Modbus configuration does not suit your needs, the existing Modbus Slave modules can be relinked to other parameters that you want to access through Modbus.

If your Modbus Master device requires data in a format different than that provided by the factory Modbus configuration, you can edit the setup registers in the Modbus Slave modules. These setup registers specify the Modbus format, scaling and base address settings. Refer to the *ION Reference* for complete details on the Modbus Slave module.

Modbus Slave Modules

Your meter is pre-configured with five modules. (ION 7650 meters with the EN50160 ordering option have 11 additional modules). The settings for your Modbus Slave modules are as follows:

Amp/Freq/Unbal

Format:	unsigned 16 bit	InZero:	0
Base Address:	40150	InFull:	6,000
Scaling:	Yes	OutZero:	0
		OutFull:	60,000

Input	Modbus Registers	Parameter
Source #1	40150	Ia
Source #2	40151	Ib
Source #3	40152	Ic
Source #4	40153	I4
Source #5	40154	I5
Source #6	40155	I avg
Source #7	40156	I avg mn
Source #8	40157	I avg mx
Source #9	40158	I avg mean
Source #10	40159	Freq
Source #11	40160	Freq mn
Source #12	40161	Freq mx
Source #13	40162	Freq mean
Source #14	40163	V unbal
Source #15	40164	I unbal
Source #16	40165	Phase Rev

Volts

Format: unsigned 32 bit InZero: 0
 Base Address: 40166 InFull: 1,000,000
 Scaling: No OutZero: 0
 OutFull: 10,000,000

Input	Modbus Registers	Parameter
Source #1	40166 to 40167	VIn a
Source #2	40168 to 40169	VIn b
Source #3	40170 to 40171	VIn c
Source #4	40172 to 40173	VIn avg
Source #5	40174 to 40175	VIn avg mx
Source #6	40176 to 40177	
Source #7	40178 to 40179	VII ab
Source #8	40180 to 40181	VII bc
Source #9	40182 to 40183	VII ca
Source #10	40184 to 40185	VII avg
Source #11	40186 to 40187	VII avg mx
Source #12	40188 to 40189	VII avg mean
Source #13	40190 to 40191	
Source #14	40192 to 40193	
Source #15	40194 to 40195	
Source #16	40196 to 40197	

kW/kVAr/kVA

Format:	signed 32 bit	InZero:	-1,000,000,000
Base Address:	40198	InFull:	1,000,000,000
Scaling:	No	OutZero:	-1,000,000
		OutFull:	1,000,000

Input	Modbus Registers	Parameter
Source #1	40198 to 40199	kW a
Source #2	40200 to 40201	kW b
Source #3	40202 to 40203	kW c
Source #4	40204 to 40205	kW tot
Source #5	40206 to 40207	kW tot max
Source #6	40208 to 40209	kVAr a
Source #7	40210 to 40211	kVAr b
Source #8	40212 to 40213	kVAr c
Source #9	40214 to 40215	kVAr tot
Source #10	40216 to 40217	kVAr tot max
Source #11	40218 to 40219	kVA a
Source #12	40220 to 40221	kVA b
Source #13	40222 to 40223	kVA c
Source #14	40224 to 40225	kVA tot
Source #15	40226 to 40227	kVA tot max
Source #16	40228 to 40229	

kWh/kVArh

Format:	signed 32 bit	InZero:	-1,000,000,000
Base Address:	40230	InFull:	1,000,000,000
Scaling:	No	OutZero:	-1,000,000
		OutFull:	1,000,000

Input	Modbus Registers	Parameter
Source #1	40230 to 40231	kWh del
Source #2	40232 to 40233	kWh rec
Source #3	40234 to 40235	kVArh del
Source #4	40236 to 40237	kVArh rec
Source #5	40238 to 40239	kVAh del+rec
Source #6	40240 to 40241	
Source #7	40242 to 40243	
Source #8	40244 to 40245	
Source #9	40246 to 40247	
Source #10	40248 to 40249	
Source #11	40250 to 40251	
Source #12	40252 to 40253	
Source #13	40254 to 40255	
Source #14	40256 to 40257	
Source #15	40258 to 40259	
Source #16	40260 to 40261	

PF/THD/Kfactor

Format:	signed 16 bit	InZero:	-100
Base Address:	40262	InFull:	100
Scaling:	No	OutZero:	-10,000
		OutFull:	10,000

Input	Modbus Registers	Parameter
Source #1	40262	PF sign a
Source #2	40263	PF sign b
Source #3	40264	PF sign c
Source #4	40265	PF sign tot
Source #5	40266	V1 THD mx
Source #6	40267	V2 THD mx
Source #7	40268	V3 THD mx
Source #8	40269	I1 THD mx
Source #9	40270	I2 THD mx
Source #10	40271	I3 THD mx
Source #11	40272	I1 K Factor
Source #12	40273	I2 K Factor
Source #13	40274	I3 K Factor
Source #14	40275	I1 Crest Factor
Source #15	40276	I2 Crest Factor
Source #16	40277	I3 Crest Factor

EN50160 Module 1

This module applies to ION 7650 meters with the EN50160 ordering option only.

Format: *Unsigned 16 bit*

Base Address: *41000*

Scaling: *No*

Input	Modbus Registers	Parameter
Source #1	41000	PO V1-Flicker N
Source #2	41001	PO V1-Flicker N1
Source #3	41002	PO V2-Flicker N
Source #4	41003	PO V2-Flicker N1
Source #5	41004	PO V3-Flicker N
Source #6	41005	PO V3-Flicker N1
Source #7	41006	PO Freq N
Source #8	41007	PO Freq N1
Source #9	41008	PO Freq N2
Source #10	41009	PO V1-Mag N
Source #11	41010	PO V1-Mag N1
Source #12	41011	PO V2-Mag N
Source #13	41012	PO V2-Mag N1
Source #14	41013	PO V3-Mag N
Source #15	41014	PO V3-Mag N1
Source#16	41015	PO Vunbal N

PO = Observation Period

EN50160 Module 2

This module applies to ION 7650 meters with the EN50160 ordering option only.

Format: *Unsigned 16 bit*

Base Address: *41016*

Scaling: *No*

Input	Modbus Registers	Parameter
Source #1	41016	PO Vunbal N1
Source #2	41017	PO V1-MSignal N
Source #3	41018	PO V1-MSignal N1
Source #4	41019	PO V2-MSignal N
Source #5	41020	PO V2-MSignal N1
Source #6	41021	PO V3-MSignal N
Source #7	41022	PO V3-MSignal N1
Source #8	41023	PO V1-Harmonic N
Source #9	41024	PO V1-Harmonic N1
Source #10	41025	PO V1-Harmonic N2
Source #11	41026	PO V2-Harmonic N
Source #12	41027	PO V2-Harmonic N1
Source #13	41028	PO V2-Harmonic N2
Source #14	41029	PO V3-Harmonic N
Source #15	41030	PO V3-Harmonic N1
Source#16	41031	PO V3-Harmonic N2

PO = Observation Period, M = Mains

EN50160 Module 3

This module applies to ION 7650 meters with the EN50160 ordering option only.

Format: *Unsigned 16 bit*

Base Address: *41032*

Scaling: *No*

Input	Modbus Registers	Parameter
Source #1	41032	PO V1-Inthrm N
Source #2	41033	PO V1-Inthrm N1
Source #3	41034	PO V2-Inthrm N
Source #4	41035	PO V2-Inthrm N1
Source #5	41036	PO V3-Inthrm N
Source #6	41037	PO V3-Inthrm N1
Source #7	41038	PO V1-Dip N11
Source #8	41039	PO V1-Dip N12
Source #9	41040	PO V1-Dip N13
Source #10	41041	PO V1-Dip N14
Source #11	41042	PO V1-Dip N21
Source #12	41043	PO V1-Dip N22
Source #13	41044	PO V1-Dip N23
Source #14	41045	PO V1-Dip N24
Source #15	41046	PO V1-Dip N31
Source #16	41047	PO V1-Dip N32

PO = Observation Period

EN50160 Module 4

This module applies to ION 7650 meters with the EN50160 ordering option only.

Format: *Unsigned 16 bit*

Base Address: *41048*

Scaling: *No*

Input	Modbus Registers	Parameter
Source #1	41048	PO V1-Dip N33
Source #2	41049	PO V1-Dip N34
Source #3	41050	PO V1-Dip N41
Source #4	41051	PO V1-Dip N42
Source #5	41052	PO V1-Dip N43
Source #6	41053	PO V1-Dip N44
Source #7	41054	PO V1-Dip N51
Source #8	41055	PO V1-Dip N52
Source #9	41056	PO V1-Dip N53
Source #10	41057	PO V1-Dip N54
Source #11	41058	PO V1-Dip N61
Source #12	41059	PO V1-Dip N62
Source #13	41060	PO V1-Dip N63
Source #14	41061	PO V1-Dip N64
Source #15	41062	PO V2-Dip N11
Source #16	41063	PO V2-Dip N12

PO = Observation Period

EN50160 Module 5

This module applies to ION 7650 meters with the EN50160 ordering option only.

Format: *Unsigned 16 bit*

Base Address: *41064*

Scaling: *No*

Input	Modbus Registers	Parameter
Source #1	41064	PO V2-Dip N13
Source #2	41065	PO V2-Dip N14
Source #3	41066	PO V2-Dip N21
Source #4	41067	PO V2-Dip N22
Source #5	41068	PO V2-Dip N23
Source #6	41069	PO V2-Dip N24
Source #7	41070	PO V2-Dip N31
Source #8	41071	PO V2-Dip N32
Source #9	41072	PO V2-Dip N33
Source #10	41073	PO V2-Dip N34
Source #11	41074	PO V2-Dip N41
Source #12	41075	PO V2-Dip N42
Source #13	41076	PO V2-Dip N43
Source #14	41077	PO V2-Dip N44
Source #15	41078	PO V2-Dip N51
Source#16	41079	PO V2-Dip N52

PO = Observation Period

EN50160 Module 6

This module applies to ION 7650 meters with the EN50160 ordering option only.

Format: *Unsigned 16 bit*

Base Address: *41080*

Scaling: *No*

Input	Modbus Registers	Parameter
Source #1	41080	PO V2-Dip N53
Source #2	41081	PO V2-Dip N54
Source #3	41082	PO V2-Dip N61
Source #4	41083	PO V2-Dip N62
Source #5	41084	PO V2-Dip N63
Source #6	41085	PO V2-Dip N64
Source #7	41086	PO V3-Dip N11
Source #8	41087	PO V3-Dip N12
Source #9	41088	PO V3-Dip N13
Source #10	41089	PO V3-Dip N14
Source #11	41090	PO V3-Dip N21
Source #12	41091	PO V3-Dip N22
Source #13	41092	PO V3-Dip N23
Source #14	41093	PO V3-Dip N24
Source #15	41094	PO V3-Dip N31
Source #16	41095	PO V3-Dip N32

PO = Observation Period

EN50160 Module 7

This module applies to ION 7650 meters with the EN50160 ordering option only.

Format: *Unsigned 16 bit*

Base Address: *41096*

Scaling: *No*

Input	Modbus Registers	Parameter
Source #1	41096	PO V3-Dip N33
Source #2	41097	PO V3-Dip N34
Source #3	41098	PO V3-Dip N41
Source #4	41099	PO V3-Dip N42
Source #5	41100	PO V3-Dip N43
Source #6	41101	PO V3-Dip N44
Source #7	41102	PO V3-Dip N51
Source #8	41103	PO V3-Dip N52
Source #9	41104	PO V3-Dip N53
Source #10	41105	PO V3-Dip N54
Source #11	41106	PO V3-Dip N61
Source #12	41107	PO V3-Dip N62
Source #13	41108	PO V3-Dip N63
Source #14	41109	PO V3-Dip N64
Source #15	41110	PO V1-Intrpt N1
Source#16	41111	PO V1-Intrpt N2

PO = Observation Period, Intrpt = Interruptions

EN50160 Module 8

This module applies to ION 7650 meters with the EN50160 ordering option only.

Format: *Unsigned 16 bit*

Base Address: *41112*

Scaling: *No*

Input	Modbus Registers	Parameter
Source #1	41112	PO V1-Intrpt N3
Source #2	41113	PO V2-Intrpt N1
Source #3	41114	PO V2-Intrpt N2
Source #4	41115	PO V2-Intrpt N3
Source #5	41116	PO V3-Intrpt N1
Source #6	41117	PO V3-Intrpt N2
Source #7	41118	PO V3-Intrpt N3
Source #8	41119	PO V1-Ovlt N11
Source #9	41120	PO V1-Ovlt N12
Source #10	41121	PO V1-Ovlt N13
Source #11	41122	PO V1-Ovlt N14
Source #12	41123	PO V1-Ovlt N15
Source #13	41124	PO V1-Ovlt N21
Source #14	41125	PO V1-Ovlt N22
Source #15	41126	PO V1-Ovlt N23
Source #16	41127	PO V1-Ovlt N24

PO = Observation Period, Ovlt = Over Voltage

EN50160 Module 9

This module applies to ION 7650 meters with the EN50160 ordering option only.

Format: *Unsigned 16 bit*

Base Address: *41128*

Scaling: *No*

Input	Modbus Registers	Parameter
Source #1	41128	PO V1-Ovlt N25
Source #2	41129	PO V1-Ovlt N31
Source #3	41130	PO V1-Ovlt N32
Source #4	41131	PO V1-Ovlt N33
Source #5	41132	PO V1-Ovlt N34
Source #6	41133	PO V1-Ovlt N35
Source #7	41134	PO V2-Ovlt N11
Source #8	41135	PO V2-Ovlt N12
Source #9	41136	PO V2-Ovlt N13
Source #10	41137	PO V2-Ovlt N14
Source #11	41138	PO V2-Ovlt N15
Source #12	41139	PO V2-Ovlt N21
Source #13	41140	PO V2-Ovlt N22
Source #14	41141	PO V2-Ovlt N23
Source #15	41142	PO V2-Ovlt N24
Source #16	41143	PO V2-Ovlt N25

PO = Observation Period, Ovlt = Over Voltage

EN50160 Module 10

This module applies to ION 7650 meters with the EN50160 ordering option only.

Format: *Unsigned 16 bit*

Base Address: *41144*

Scaling: *No*

Input	Modbus Registers	Parameter
Source #1	41144	PO V2-Ovlt N31
Source #2	41145	PO V2-Ovlt N32
Source #3	41146	PO V2-Ovlt N33
Source #4	41147	PO V2-Ovlt N34
Source #5	41148	PO V2-Ovlt N35
Source #6	41149	PO V3-Ovlt N11
Source #7	41150	PO V3-Ovlt N12
Source #8	41151	PO V3-Ovlt N13
Source #9	41152	PO V3-Ovlt N14
Source #10	41153	PO V3-Ovlt N15
Source #11	41154	PO V3-Ovlt N21
Source #12	41155	PO V3-Ovlt N22
Source #13	41156	PO V3-Ovlt N23
Source #14	41157	PO V3-Ovlt N24
Source #15	41158	PO V3-Ovlt N25
Source #16	41159	PO V3-Ovlt N31

PO = Observation Period, Ovlt = Over Voltage

EN50160 Module 11

This module applies to ION 7650 meters with the EN50160 ordering option only.

Format: *Unsigned 16 bit*

Base Address: *41160*

Scaling: *No*

Input	Modbus Registers	Parameter
Source #1	41160	PO V3-Ovlt N32
Source #2	41161	PO V3-Ovlt N33
Source #3	41162	PO V3-Ovlt N34
Source #4	41163	PO V3-Ovlt N35

PO = Observation Period, Ovlt = Over Voltage

Importing Data using Modbus RTU

It is possible to bring data into the meter using Modbus. Various ION registers can be written by Modbus Master devices by correlating the Modbus register number with the address of the ION register you want to write. When a Modbus register is written with a value, the corresponding ION register will be written, provided the Modbus RTU protocol is active on the communications channel that connects the Modbus Master to the meter.

You can use the Modbus RTU protocol to write values into ION external numeric, pulse and Boolean registers, allowing you to enable, disable and reset meter functions. You can also use the Modbus protocol to change setup register values in various ION modules to configure the meter's operation. To bring data into the meter with Modbus RTU, you must disable the meter's password security.

Using the Modbus/TCP Protocol

Modbus/TCP is the newest open Modbus protocol variant (formerly called MBAP). It defines the packet structure and connection port (port 502) for the industry standard TCP/IP protocol. The structure of Modbus/TCP is very similar to the Modbus RTU packet except that it has an extra six-byte header and does not use the cyclic redundancy check (CRC). Modbus/TCP retains the Modbus RTU limit of 256 bytes to a packet.

Modbus TCP Communications

You can communicate to the meter using Modbus TCP (formerly called MBAP). Your meter must have the optional Ethernet port. Connect to socket **502**.

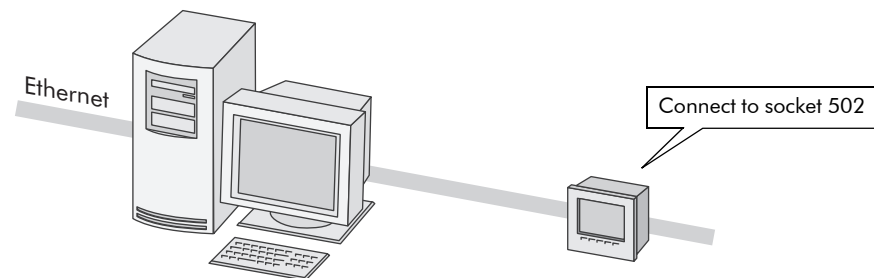

NOTE

You cannot form an EtherGate connection to the Modbus TCP network.

The Meter as Modbus Master

Your meter can act as a Modbus Master using the Modbus RTU and Modbus/TCP protocols. However, only a serial connection is supported between the ION 7550 / ION 7650 meter and the Modbus Slave devices.

The ION meter acting as Modbus Master can write data to (export), and read data from (import) Modbus Slave devices, using various ION modules. The data can be processed by the meter and sent out using other communications methods (email, ION software, etc.). The meter can also send control commands or data directly to other devices on a Modbus network.

The Factory Modbus Master Configuration

There is no pre-configured framework for Modbus mastering on your meter. Your meter's template contains Modbus Import modules that can read values and Modbus Export modules that can write data but they must be enabled and configured in a framework first.

See the *Modbus and ION Technology* technical for more information on Modbus Master configuration for your meter.

Configuring Modbus

Using the Front Panel

You cannot configure Modbus through the meter's front panel. You can only assign the Modbus protocol to communication ports. See the Communications chapter for details.

Using ION Setup

The Modbus Setup Assistant helps you configure Modbus Master and Slave functionality for your meter.

1. Open ION Setup and connect to your meter, using Basic Mode.
2. In the Setup Assistant, navigate to Communications > 3rd Party Protocols
3. Click on the Modbus Slave tab to edit the Modbus Slave modules.
4. Select the map name (in this example, the default map) and click Edit.

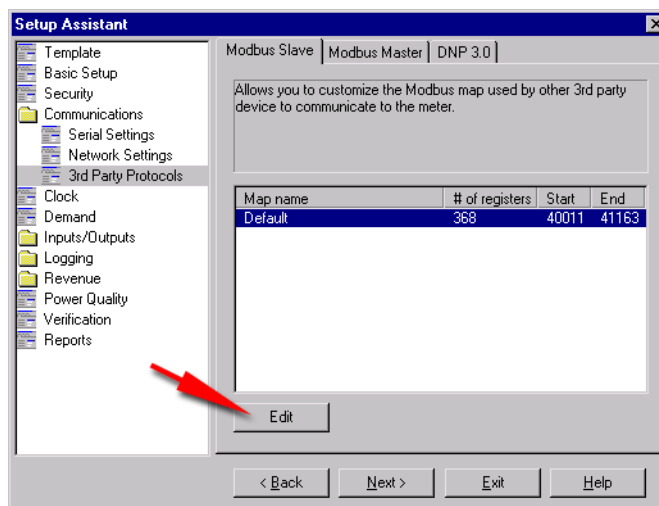

5. The default Modbus map editor appears, allowing you to edit, add, delete or set the name of Modbus Slave module registers.

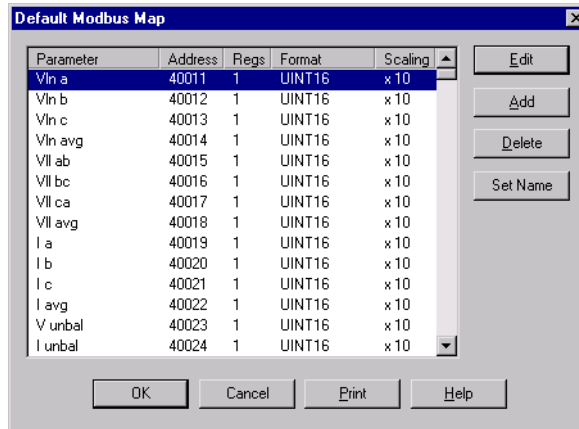

6. Click on the Modbus Master tab to edit the Modbus Import modules.
7. Click the Add button to add a Modbus Slave device.

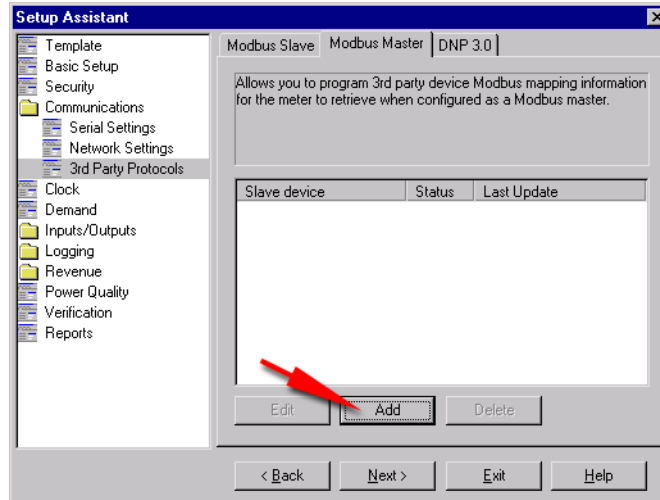

8. The Modbus Device screen appears. Enter the Slave device's information (in this example, an ION 6200) and click OK to add.

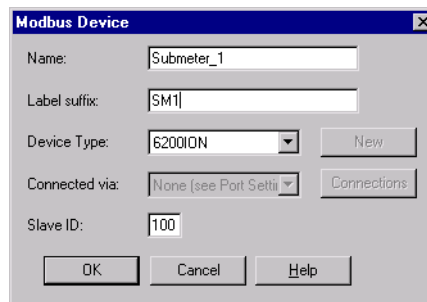

See the *Modbus and ION Technology* technical note for more information.

Using the DNP 3.0 Protocol

The Distributed Network Protocol Version 3.0 (DNP 3.0) is an open protocol used in the electric utility industry for communications and interoperability among substation computers, Remote Terminal Units (RTUs), Intelligent Electronic Devices (IEDs, e.g. meters), and Master Stations.

Your meter can be integrated into a DNP network as a DNP Slave, using the DNP Slave Import, DNP Slave Export and DNP Slave Options modules. For more information on the various DNP modules, see the *ION Reference*.

Your meter supports a maximum of three concurrent connections (or “sessions”) using the DNP 3.0 protocol; one for each serial port, up to three using Ethernet, or a combination of both. Combinations available will depend on the meter's communications options. A session consists of all incoming and outgoing DNP Master/Slave traffic on one of the meter's communications ports.

Consult the DNP User's Group at <http://www.dnp.org/> to learn more about the protocol.

The Factory DNP 3.0 Configuration

Your meter is pre-configured with a DNP framework that allows for basic DNP Slave functionality. DNP Slave Export modules are used to send data to the DNP Master while DNP Slave Options modules provide per-session settings such as communications options. Although some minor setup of the framework is necessary before it becomes enabled (assigning the DNP protocol to the communications ports etc.), most module settings should not require alteration.

For information on your meter's default DNP map and factory configuration, see the *ION 7550 / ION 7650 DNP 3.0 Device Profile*.

Importing Data using DNP 3.0

Data can be imported into the meter from a DNP control relay or analog output device. DNP Slave Import modules are used to take a DNP Analog output or Binary output object and map them into ION registers.

NOTE

DNP Slave Import modules are not part of the factory DNP framework and must be added manually. Refer to the DNP Slave Import module description in the *ION Reference* for details.

Configuring DNP 3.0

If the factory DNP configuration does not suit your needs, you can relink the existing DNP Slave Export modules to access a different set of parameters through DNP. Alternately, you can add additional DNP Slave Export modules and link the desired ION parameters to them.

If your DNP network requires data in a format different than that provided by the factory DNP configuration, you can edit the setup registers in the DNP Slave Export modules and the DNP Slave Options modules. Do not make any changes to the DNP Slave Options modules' setup registers unless you understand the effects each change will cause. Refer to the *ION Reference* for complete details on DNP Slave Export and DNP Slave Options module function.

For detailed information on configuring your meter to use DNP, see the *Multiport DNP and ION Technology* technical note.

Using the Front Panel

You cannot configure DNP through the meter's front panel. You can only assign the DNP 3.0 protocol to communication ports. See the Communications chapter.

Using ION Setup

The DNP 3.0 Setup Assistant helps you configure the DNP Slave Export and DNP Slave Options modules.

1. Open ION Setup and connect to your meter, using Basic Mode.
2. In the Setup Assistant, navigate to Communications > 3rd Party Protocols and click on the DNP 3.0 tab.
3. Select the DNP feature you wish to configure (Parameter Map in this example) and click Edit.

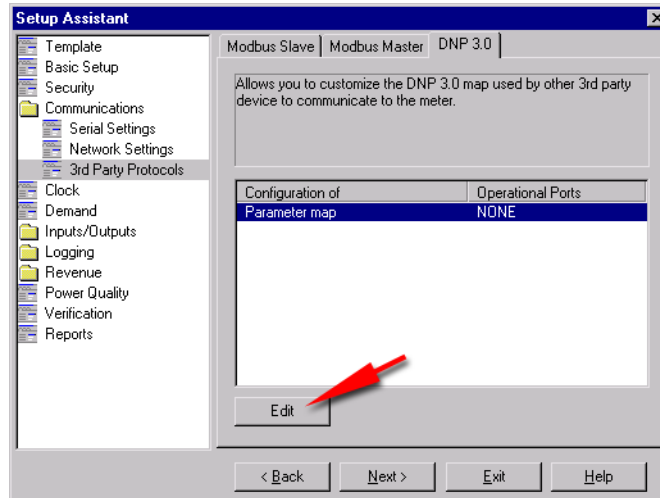

4. The Setup Assistant guides you through DNP configuration. See the *ION Setup Online Help* for more information.



chapter
8

Time

This chapter covers the meter's clock and time synchronization.

In This Chapter

◆ Meter Clock	108
Configuring the Meter Clock	108
Using the Front Panel	108
Using ION Setup	109
Using Designer	110
Clock Module Settings	110
◆ Time Synchronization	112

Meter Clock

The Clock module controls the meter's internal clock, which provides timestamps for data logged by the device. The clock needs to be configured properly to ensure that logged data has accurate timestamp information. The Clock module also receives the time synchronization signals sent to it by the workstation running ION software, updating the device's clock when required.

The Clock module's *Clock Source* setup register defines how the meter's internal clock auto-corrects drift from its internally calculated time. A separate time source (such as a GPS receiver, an NTP server or a DNP Master) can be used to synchronize the clock through a communications channel.

See the *ION Reference* for more information on the Clock module.

Configuring the Meter Clock

Use the front panel or ION software to change the meter's clock settings.

Using the Front Panel

The Time Setup menu provides access to various time-related parameters in the meter, such as the synchronization sources and channels used, and the time offsets applicable to your location.

The Clock Setup sub-menu contains settings for the meter's time keeping and time synchronization methods. Changing the settings under Clock Setup alters the setup register values of the Clock module — the module that provides timestamps for the data logged by the meter.

TZ Offset (hh:mm)

Set this value to the time zone of the meter's location, relative to Coordinated Universal Time (UTC). For example, an entry of -08:00 is the correct offset for Pacific Time in the USA, Canada, and Tijuana. Specify a positive (+) or negative (-) offset with the Navigation buttons. The value must be non-zero before you can change its sign.

DST Offset (hh:mm)

This setting determines the daylight savings time offset applicable to your location. The DST offset is the amount of time that the clock is moved when Daylight Savings time begins or ends. For example, an entry of +01:00 sets a daylight savings time offset of one hour. Setting DST offset to 0 (zero) disables daylight savings entirely. Specify a positive (+) or negative (-) offset with the Navigation buttons. The value must be non-zero before you can change its sign.

NOTE

The Clock Module's *DST Start* and *DST Stop* setup registers control the start and end times for Daylight Savings for up to twenty consecutive years. These registers are already configured in the factory but can be changed using ION software.

Sync Source

This setting determines the port responsible for receiving the time synchronization signals. Only signals received on the selected port are used to synchronize the meter's internal clock; time synchronization signals on all other ports are ignored. The choices are ETHERNET, COM1, COM2, COM3 and COM4.

Refer to the *Time Synchronization & Timekeeping* technical note for more details on synchronization sources.

Sync Type

This setting specifies whether time synchronization signals are received in UTC (Coordinated Universal Time) or Local Time. The default is set to UTC for ION Enterprise. Some DNP masters use Local Time.

Clock Source

This item determines the time synchronization source. The meter clock can be synchronized from an internal crystal (Internal), or through a communications port (COMM). If you are using GPS time synchronization, change this setting to COMM.

The Set Meter Time sub-menu contains settings for the date and time displayed on the front panel. The Meter Time settings are dependent upon the configuration of the Clock Setup menu—you must set the time zone offset (TZ Offset) prior to setting the Local Date and Time.

Local Date

Use this item to set the meter's display to the current date. The format of the date is defined in the General Format Setup menu.

Local Time

Use this item to set the meter's display to local time.

Using ION Setup

The Clock Setup Assistant helps you configure the Clock module.

1. Open ION Setup and connect to your meter, using Basic Mode.
2. In the Setup Assistant, navigate to the Clock folder.

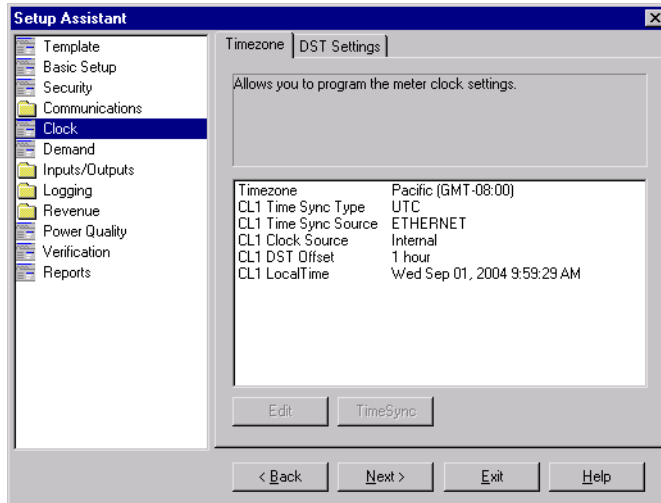

3. Click on the Timezone tab to configure your meter’s clock settings. Select a parameter and click Edit to change.
4. Click on the DST Settings tab to configure your meter’s daylight savings periods for up to 20 years. Select a parameter and click Edit to change.

Using Designer

Open your meter in Designer and navigate to the Meter Clock Setup framework. Right-click on the Clock module to edit.

Clock Module Settings

The setup registers in the Clock module specify time zone, Daylight Savings Time (DST) parameters and time synchronization functions.

Setup Register	Function
TZ Offset	Sets the time zone the device is in, relative to Greenwich Mean Time.
DST Start 1 ... DST Start 20	The date and time when DST begins for 20 separate years.
DST End ... DST End 20	The date and time when DST ends for 20 separate years.
DST Offset	The amount of time the clock is changed when DST begins or ends.
Time Sync Source	Specifies the communications port that receives time sync signals.
Time Sync Type	Specifies the type of time sync signal (Local or Universal time).
Clock Source	Specifies the clock’s time synchronization signal source (communications signals, or internal crystal).



When modifying setup registers of the Clock module in Designer, use the Format option to convert between UNIX and conventional time.

Typically, the *DST Start* and *DST End* registers do not have to be reconfigured. The factory defaults are the DST start and end dates for 20 years, in UNIX time (the number of seconds since 00:00:00 UTC on January 1, 1970).

Time Synchronization

Time synchronization lets you synchronize your meter's internal clock with all of the other meters, devices, and software in a network. Once synchronized, all data logs have timestamps that are relative to a uniform time base. This allows you to achieve precise sequence-of-events and power quality analyses. Use ION software to broadcast time signals across the network, or utilize an external source (such as an NTP server or DNP Master) to synchronize your meter's clock.

Refer to the technical note *Time Synchronization & Timekeeping* for more information on implementing time synchronization.



chapter
9

Demand

This chapter explains how to configure and view demand values on your meter.

In This Chapter

◆ Introduction	114
◆ Configuring Demand	114
Using the Front Panel	114
Using ION Setup	114
Using Designer	115
Sliding Window Demand Module Settings	115
Thermal Demand Module Settings	115
◆ Displaying Demand	116

Introduction

Demand is a measure of average power consumption over a fixed time interval. Peak (or maximum) demand is the highest demand level recorded over the billing period. Two methods of measuring demand are with Thermal Demand modules and Sliding Window Demand modules. These modules are configured to calculate the average current demand and kW, kVAR and kVA demand. The setup registers in the demand modules define time intervals for demand calculations, setting the sensitivity of the module's operation.

See the *ION Reference* for more information about these modules.

Configuring Demand

Use ION software to change your meter's demand settings.

Using the Front Panel

You cannot configure Demand using the front panel.

Using ION Setup

The Demand Setup Assistant helps you configure Sliding Window Demand only. This screen also contains two registers used for configuring Sliding Window Demand while the meter is in Test Mode.

1. Open ION Setup and connect to your meter, using Basic Mode.
2. In the Setup Assistant, navigate to the Demand folder.

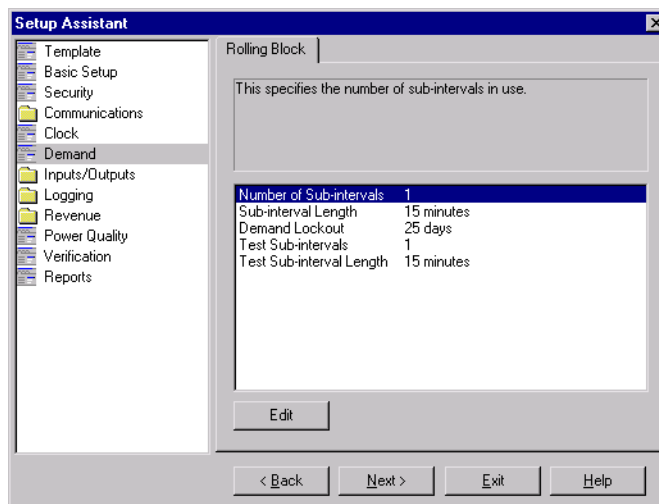

3. Configure Rolling Block demand by selecting a register and clicking Edit.

You can configure **both** the Sliding Window Demand and Thermal Demand modules using Advanced Mode.

1. Connect to your meter, using Advanced Mode.
2. Click on the module you wish to configure.

Using Designer

Open your meter in Designer and navigate to the Demand Setup framework. There are two sections: Sliding Window Demand setup and Thermal Demand setup. Right-click on a module to edit.

Sliding Window Demand Module Settings

Sliding Window Demand is often referred to as Rolling Block Demand. To compute sliding window demand values, the Sliding Window Demand module uses the sliding window averaging (or rolling interval) technique which divides the demand interval into sub-intervals. The demand is measured electronically based on the average load level over the most recent set of sub-intervals. This method offers better response time than fixed interval methods.

Setup Register	Function	Default
Sub Intvl	The time, in seconds, in the sliding window demand sub-interval.	900
#SubIntvls	The number of sub-intervals in the sliding window.	1
Pred Resp	The speed of Predicted Demand calculations; use higher values for faster prediction (70 to 99 recommended).	70
Update Rate	Defines the update rate of the <i>SWinDemand</i> output register	End of Sub-Interval

Thermal Demand Module Settings

The Thermal Demand module calculates thermal demand over a specified length of time. It uses a method which is equivalent to thermal averaging. For thermal averaging, the traditional demand indicator responds to heating of a thermal element in a Watt-Hour meter. Adjust the Thermal Demand module's calculation to mimic this technique by changing the *Time Const* and *Interval* setup parameters.

Setup Register	Function	Default
Interval	The time, in seconds, in the thermal demand interval.	900
Time Const	The sensitivity to changes in the source signal; higher values provide faster response time (common values are 63 and 90).	90

Displaying Demand

View Demand values in the following locations:

Application	Menu	Navigation
Front Panel	Demand1, Demand2 screens	Press Demand1 and Demand2 softkeys
ION Setup	Demand Display Screen	Display Mode > Demand
Vista	Energy & Demand Screen (SWD) Energy & Demand Screen (Thermal)	Revenue Tab Revenue > Thermal Demand object
WebMeter	Consumption Screen	Consumption link



chapter
10

Inputs / Outputs

This chapter provides information on the meter's various digital and analog inputs and outputs (I/O).

Refer to your Installation Guide for instructions on wiring inputs and outputs and for the general meter I/O specifications.

In This Chapter

◆ Digital I/O	118
Specifying a Port in an ION Module	118
Using the Onboard Digital Outputs	120
Using the Onboard Digital Inputs	122
◆ Analog I/O (optional)	123
Specifying a Port in an ION Module	123
Using the Analog Inputs	124
Using the Analog Outputs	125
◆ Configuring Inputs and Outputs	126

Digital I/O

ION 7550 and ION 7650 meters offer a variety of I/O combinations. The following are standard for all meters:

- ◆ 8 digital (status) inputs
- ◆ 4 form A digital (solid-state) outputs
- ◆ 3 form C relay outputs (electromechanical)
- ◆ 2 front panel LED outputs

The digital inputs are ideal for monitoring status or counting pulses from external dry contacts. Use the Form A outputs for performing end of interval pulsing, load control and alarm annunciation, and the Form C relays for load switching applications. The LED outputs are suitable for energy pulsing and alarming.

The meter is also available with an optional I/O card that can include additional digital inputs. Refer to the meter's datasheet for the ordering options available on the optional I/O card.

This card does not need to be ordered with your meter; it can be retrofitted to meters already operating in the field.

Digital Input modules control the meter's digital inputs. The outputs can be controlled by Digital Output modules, Pulser modules, or Calibration Pulser modules. All of these modules act as intermediaries between the hardware port and the other modules in the meter; they define the characteristics of outgoing signals or tell the meter how to interpret incoming signals.

Refer to the technical note *Digital and Analog I/O* for more information on digital inputs and outputs.

Specifying a Port in an ION Module

Configure the Digital Output, Digital Input, Pulser, and Calibration Pulser modules' *Port* setup registers to specify which port handles the outgoing or incoming signals. To assign a port to one of these modules, simply modify the *Port* setup register by picking a port from the enumerated list. This can be done with both Designer and ION Setup.

Be aware that the enumerated list only displays those ports that are not yet assigned to another module. For example, the meter's factory configuration makes use of Digital Output DO4 (it is already assigned to Calibration Pulser module "kWh Pulser -D4"). If you create a new Digital Output module and go to set its *Port* setup register, the port DO4 will not appear in the list of available ports.

To make a port available, you must first locate the module controlling the port and set its *Port* setup register to NOT USED (or delete the module entirely). The port now appears in the enumerated list.

The following table describes the ports that can be configured (in the Digital Output, Pulser, Digital Input, and Calibration Pulser modules) to handle digital outgoing or incoming signals.

Standard Output Port Names	Description
Port R1	Digital (Form C Relay) Output port 1
Port R2	Digital Output port 2
Port R3	Digital Output port 3
Port D1	Digital (Form A Solid-State) Output port 4
Port D2	Digital Output port 5
Port D3	Digital Output port 6
Port D4	Digital Output port 7
kWh Pulse –LED	LED Output
Alarm LED	LED Output
Standard Input Port Names	Description
Port S1	Digital (Status) Input port 1
Port S2	Digital Input port 2
Port S3	Digital Input port 3
Port S4	Digital Input port 4
Port S5	Digital Input port 5
Port S6	Digital Input port 6
Port S7	Digital Input port 7
Port S8	Digital Input port 8
Optional Input Port Names	Description
Port DI1	Digital (Status) Input port 9
Port DI2	Digital Input port 10
Port DI3	Digital Input port 11
Port DI4	Digital Input port 12
Port DI5	Digital Input port 13
Port DI6	Digital Input port 14
Port DI7	Digital Input port 15
Port DI8	Digital Input port 16

Using the Onboard Digital Outputs

Use the meter's digital outputs for hardware relay control or pulse counting applications. For example, your meter's digital outputs can provide on/off control signals for capacitor banks, generators, and other equipment. The digital output ports can also send out status signals or kWh pulses, if the receiving device determines energy usage by counting pulses.

The meter provides three Form C mechanical relays and four Form A digital (solid-state) relays. All digital outputs can deliver a continuous signal or a pulse.

Contact Power Measurement for complete information regarding relay applications.

CAUTION

The relay outputs of the meter should never be used for primary protection functions. Be sure that you are familiar with the warnings at the beginning of this document, as well as those presented in your meter's Installation Guide.

These outputs can be controlled by Digital Output modules, Pulser modules, or Calibration Pulser modules, depending on the application. For relay and control, use the Digital Output module. For pulsing applications, the Pulser and Calibration Pulser modules are generally used.

NOTE

Because mechanical relays have limited lifetimes, mechanical KYZ relays are typically not suitable for energy pulsing applications. For energy pulsing applications, consider using Form A outputs in KYZ mode.

Digital Output Modules

Both the Form A and Form C relays can be controlled with Digital Output modules, Pulser modules, or Calibration Pulser modules. By default, six Digital Output modules (labeled DO-D1 to DO-D3 and DO-R1 to DO-R3) are already created for this purpose. You can use these modules, or create and configure other modules to control the output ports.

- ◆ **Calibration Pulser modules** allow you to generate high accuracy energy pulses for calibration testing purposes. They integrate instantaneous power appearing at their inputs.
- ◆ **Digital Output modules** accept Boolean inputs, and output a continuous signal or pulses.
- ◆ **Pulser modules** convert instantaneous pulses to pulses or transitions.

Consult the *ION Reference* for more information about these ION modules.

Configure the settings of the controlling module to match your requirements. The settings in these modules are as follows:

ION Module	Setup Registers	Available Settings	Creation Default	Description
Digital Output	Port	Not Used Port DO1 Port DO2 Port DO3 Port DO4 Port R1 Port R2 Port R3 kWh Pulse –LED Alarm LED	Not Used	The output hardware channel
	Pulse Width	0 to 2000000	0	Pulse Width, in seconds (0 for continuous pulse)
	Polarity	Inverting or Non-Inverting	Non-Inverting	Inverted or non-inverted output
	EvLog Mode	Log on or Log off	Log off	Whether or not to log status changes in the Event Log
Pulser	Port	As per Digital Output, above	Not Used	The output hardware channel
	PulseWidth	0.020 to 2000000	1	Pulse width, in seconds
	OutputMode	Pulse or KYZ	Pulse	Full pulse or KYZ (transition pulse)
	Polarity	Inverting or Non-Inverting	Non-Inverting	Inverted or non-inverted output
Calibration Pulser	Port	As per Digital Output, above	Not Used	The output hardware channel
	Pulse Width	0.010 to 1.000	0.05	Pulse Width, in seconds
	Kt	0.01 to 1000000000	1.8	Watts per pulse
	Int Mode	Forward, Reverse, Absolute, or Net	Absolute	Integration modes that may be selected
	OutputMode	Pulse or KYZ	Pulse	Full pulse or KYZ (transition pulse)

Ensure that the module's *Port* setup register matches the meter's output you want to control. If the port you want to use does not appear in the *Port* setup register's list, it means that port is in use by another module. Edit the *Port* setup register of the module using that port and set it to NOT USED – the port will then be available to other modules.

Calibration Pulsing Relay DO4

Solid-state relay DO4 is factory configured for calibration pulsing and requires no further setup. The Calibration Pulser module labeled *kWh Pulser –D4* controls this port. By default, the module is linked to the *kW del+rec* output of the Arithmetic module labeled "*del, rec*" in the Demand Framework. This Arithmetic module is linked to the MU Power Meter module's *MU kW tot* output. The port will output a pulse for every 1.8 Wh accumulated (in NORMAL or TEST mode); this is the same pulsing rate as the middle LED on the front panel of the meter. See the Energy Pulsing chapter for more information



Alarm LED

Use the red (bottom) LED on the front panel of the meter for custom alarming applications. It can be linked to a framework to provide event notification. Possible applications include sag/swell alarming, setpoint annunciation, and tariff notification. Like all outputs on the meter, this port can be controlled by a Digital Output, Pulser, or Calibration Pulser module.

Using the Onboard Digital Inputs

Use the meter's digital inputs for status monitoring or pulse counting applications. Status monitoring can help you prevent equipment damage, improve maintenance, or track security breaches. Some common status monitoring applications are monitoring the closed/open positions of breakers, on/off status of generators, armed/unarmed conditions in a building alarm system, and over/under pressures of transformers.

Digital Input modules control the function of each status input, telling the meter how to interpret incoming signals. Digital Input modules can be linked with other modules for counting status changes.

Digital Input Modules

The meter provides eight default Digital Input modules (labeled DI-S1 to DI-S8) for the onboard status inputs. Configure the settings of the controlling module to match your requirements.

NOTE

The Digital Inputs on the Optional I/O card are controlled by the Digital Input modules I/O-S1 to I/O-S8. However, on the Optional I/O card itself, the inputs are labelled DI1 to DI8

The settings in the Digital Input modules are as follows:

Setup Register	Available Settings	Creation Default	Description
Input Mode	Pulse or KYZ	Pulse	Complete pulse or KYZ transition pulse
EvLog Mode	Log Off or Log On	Log Off	Whether or not to log status changes in the Event Log
Debounce	0 to 65.25	0.010	Mechanical contact bounce, in seconds
Polarity	Non-Inverting or Inverting	Non-Inverting	Non-inverted (or level) pulse
Port	Not Used Port DI1 Port DI2 Port DI3 Port DI4 Port DI5 Port DI6 Port DI7 Port DI8	Not Used	The input hardware channel controlled

Analog I/O (optional)

Analog I/O ports are found on the optional I/O card, which can include analog inputs and/or analog outputs or additional digital inputs. Use analog inputs to monitor a wide range of conditions, such as flow rates, RPM, fluid levels, oil pressures and transformer temperatures. Analog outputs let you output real-time power to an RTU or perform equipment control operations.

Refer to the meter's datasheet for the ordering options available on the optional I/O card.

NOTE

This card does not need to be ordered with your meter; it can be field retrofitted.

Refer to the technical note *Digital and Analog I/O* for more information on analog inputs and outputs.

Your meter uses Analog Input and Analog Output modules for analog I/O. See the *ION Reference* for more information on these modules.

Specifying a Port in an ION Module

Configure the Analog Output and Analog Input modules' *Port* setup registers to specify which port handles the outgoing or incoming signals. To assign a port to one of these modules, simply modify the *Port* setup register by picking a port from the enumerated list. This can be done with both Designer and ION Setup.

The following table describes the ports that can be configured in the Analog Input and Analog Output modules to handle outgoing or incoming analog signals.

Optional Output Port Names	Description
Port AO1	Analog Output port 1
Port AO2	Analog Output port 2
Port AO3	Analog Output port 3
Port AO4	Analog Output port 4
Optional Input Port Names	Description
Port AI1	Analog Input port 1
Port AI2	Analog Input port 2
Port AI3	Analog Input port 3
Port AI4	Analog Input port 4

Using the Analog Inputs

Use the analog inputs to measure and store analog information such as electrical signals from transducers (from flow rates, temperatures, pressures, rotations, and fluid levels). Analog Input modules control the analog inputs.

Analog Input Modules

The optional I/O card provides four analog inputs. By default, four Analog Input modules (labeled AI1 to AI4) are already created for this purpose. Configure the settings of the controlling module to match your requirements. The settings in these modules are as follows:

Setup Registers	Available Settings	Creation Default	Description
Port	Not Used or AI1 to AI4 inclusive	Not Used	The input hardware channel
Full Scale	-1×10^9 to 1×10^9	1	Defines what value appears in the ScaledValu output register when the highest possible value from the hardware is applied
Zero Scale ¹	-1×10^9 to 1×10^9	0	Defines what value appears in the ScaledValu output register when the lowest possible value from the hardware is applied

¹ An arbitrary input value can be treated as the Zero Scale (i.e., a 4-20mA input is capable of generating a 0 to X output).

Using the Analog Outputs

Your meter's analog outputs act as transducers. The meter measures power and energy, and then sends that information via the analog outputs to a remote terminal unit (RTU). The analog outputs issue industry standard 0 to 20 mA current signals. They are controlled by the Analog Output modules.

Analog Output Modules

The optional I/O Card provides four analog outputs. By default, four Analog Output modules (labeled AO1 to AO4) are already created for this purpose. Configure the settings of the controlling module to match your requirements. The settings in these modules are as follows:

Setup Registers	Available Settings	Creation Default	Description
Port	Not Used AO1 to AO4 inclusive	Not Used	The output hardware channel
Full Scale	-1×10^9 to 1×10^9	1	Defines what value appears in the ScaledValue output register when the highest possible value from the hardware is applied
Zero Scale	-1×10^9 to 1×10^9	0	Defines what value appears in the ScaledValue output register when the lowest possible value from the hardware is applied

Configuring Inputs and Outputs

Use ION software to configure the meter's I/O framework.

Using the Front Panel

You cannot configure I/O using the Front Panel.

Using ION Setup

The Inputs/Outputs Setup Assistant helps you configure the Calibration Pulser modules and the Analog Output modules. See the Energy Pulsing chapter for information on configuring the Calibration Pulser modules in ION Setup.

1. Open ION Setup and connect to your meter, using Basic Mode.
2. In the Setup Assistant, navigate to Inputs/Outputs > Analog Outputs

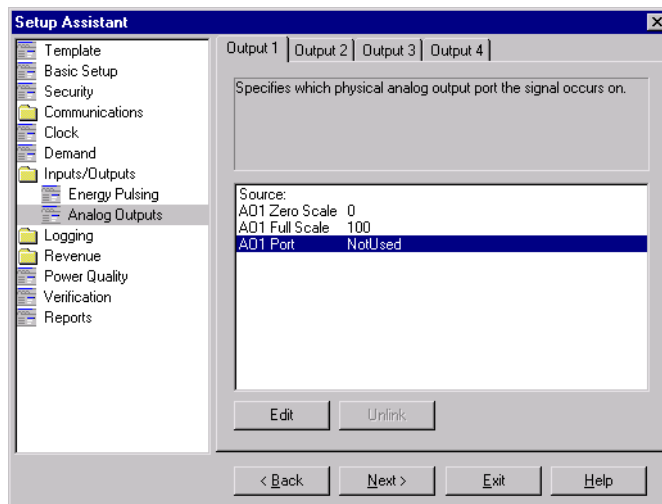

The tabs on the Analog Outputs screen correspond to Analog Output modules (for example, Output 1 allows you to configure Analog Output module 1). Click on the tab you wish to edit.

3. To edit a value select the parameter and click Edit.
4. To link an Analog Input module to a source (by default, none are linked) select Source and click edit. Navigate to the source register you require and click OK.

Using Designer

Open your meter in Designer and navigate to the Advanced Configuration framework. Click on the appropriate grouping object (Digital Inputs, Digital Outputs or Analog I/O) and right-click the module you want to edit.



chapter
11

Energy Pulsing

This chapter provides instructions for configuring energy pulsing on your meter.

In This Chapter

◆ Introduction	128
◆ Configuring Energy Pulsing	128
Using the Front Panel	128
Using ION Setup	128
Using Designer	129
Pulser Module Settings	129
Calibration Pulser Module Settings	130
◆ Energy Pulsing with LEDs	131

Introduction

Your meter uses Calibration Pulser modules and Pulser modules for energy pulsing.

The Pulser module serves as an intermediary between other modules' pulse output registers (accepting them as pulse inputs) and a hardware output channel on the device. These modules are capable of sending pulses or pulse transitions to any hardware output channel.

The Calibration Pulser module is a highly accurate energy pulser used for verifying calibration on meters employed in billing applications. This module type serves as an intermediary between the power (kW, kVAR or kVA) outputs of the Power Meter module and a device's hardware output channel.

See the *ION Reference* for more information on these modules.

Configuring Energy Pulsing

Use ION software to change your meter's energy pulsing settings.

Using the Front Panel

You cannot configure Energy Pulsing using the front panel.

Using ION Setup

The Energy Pulsing Setup Assistant helps you configure the Calibration Pulser modules.

1. Open ION Setup and connect to your meter, using Basic Mode.
2. In the Setup Assistant, navigate to Inputs/Outputs > Energy Pulsing

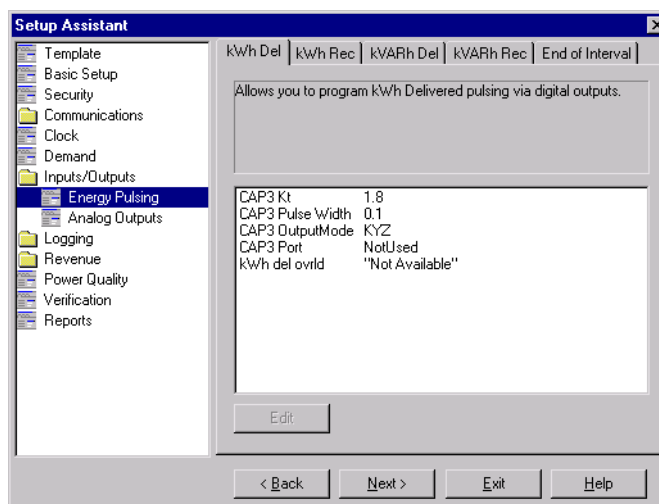

3. Click any of the first four tabs; each tab corresponds to a Calibration Pulser module. Configure each module as necessary.
4. Click the End of Interval tab to configure the end of energy pulsing.

You can configure *both* the Calibration Pulser and Pulser modules using Advanced Mode.

1. Connect to your meter, using Advanced Mode.
2. Click the module you wish to configure.

Using Designer

Open your meter in Designer and navigate to the Energy Pulsing Setup Framework. Right-click a module to edit.

Pulser Module Settings

The Pulser module contains the following setup registers:

Setup Register	Function	Default
Pulse Width	This register specifies the width of the output pulses (in seconds).	1
OutputMode	This register defines whether the output is a complete pulse or a transition pulse (KYZ).	Pulse
Polarity	This register specifies the polarity of a pulse output. It has no effect if <i>OutputMode</i> is KYZ.	Non-inverting
Port	This register specifies which hardware port the output appears on. Only those hardware channels that are still available appear in this list.	Not Used

Five common parameters (kWh del, kWh rec, kVARh del, kVARh rec, and kW sd del) are already linked to the Pulser modules for you.

NOTE

For safety reasons, no hardware channel is pre-selected. To make use of these links, you must configure the Pulser modules' *Port* setup registers to the appropriate hardware port that receives the output.

Calibration Pulser Module Settings

Configure the solid-state output D4 for calibration pulsing by editing the setup registers of the module labeled “kWh Pulser –D4”. By default, the output on a standard meter generates a pulse for every 1.8 Wh accumulated. This is the same pulsing rate as the middle front panel LED (controlled by a Calibration Pulser module labeled “kWh Pulser –LED”). Modify the pulsing rate of either channel by changing the value of the *Kt* setup register of the Calibration Pulser module controlling them (see below).

The following setup registers are available in the Calibration Pulser module:

Setup Register	Function	Default
Pulse Width	This register specifies the width of the pulses sent to the hardware channel (in seconds). The Calibration Pulser module maintains a minimum duty cycle of 50% on the output pulse train.	0.05
Kt	The numeric bounded register defines how much energy the module accumulates before a pulse is sent to the hardware channel. An industry standard for energy pulsing is 1.8, or one pulse per 1.8 energy-hours.	1.80
Int Mode	Specifies the modes of integration that may be selected.	Absolute
OutputMode	This register specifies whether the output is a complete pulse (Pulse) or a change of state transition (KYZ).	Pulse
Port	This register specifies which hardware port the pulse/KYZ transition appears on. Only those hardware channels that are still available appear in this list.	Not Used

Energy Pulsing with LEDs



The middle green LED on the meter’s front panel is factory configured to be an energy pulser. Like solid-state relay output DO4, the kWh Pulser –LED is controlled by a Calibration Pulser module that has its *Source* input linked to the *kW del+rec* output of the Arithmetic module labeled “*del, rec.*”. This Arithmetic module is linked to the MU Power Meter module’s *MU kW tot* output. The LED port outputs a pulse for every 1.8 Wh accumulated (in both NORMAL and TEST mode).

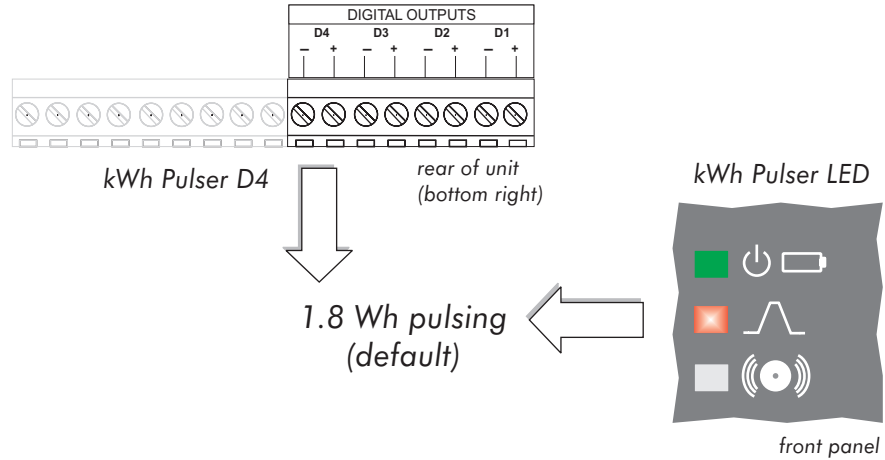

Changing the value for the *Kt* setup register of the controlling Calibration Pulser module lets you modify the pulsing rate of either channel. If you want to configure the LED port for a different pulsing application, you must re-link the *Source* input to the output register of a different instantaneous power quantity in one of the Arithmetic modules in the Demand Framework. Ensure that the quantity you choose originates from the MU (meter units) Power Meter module.

chapter
12

Logging

Your meter includes data logging and event recording capabilities. Data and event logs recorded by the meter are prioritized and stored onboard. This data is then retrieved periodically by the ION Enterprise Log Server or another third party application.

If you use ION Enterprise software, all retrieved data from your system is stored in an ODBC-compliant database. The information in the database can be viewed and analyzed using ION Enterprise software applications such as Vista (for viewing), or Reporter (for organizing and presenting data).

For more information on Vista and Reporter see the online *ION Enterprise Help*.

In This Chapter

◆ Data Logging	134
Configuring Data Logging	134
Using the Front Panel	134
Using ION Setup	134
Changing the Parameters that are Logged	136
Changing Waveform Recording	136
Default Logging Capacity	136
Changing the Log Depths	137
Changing the Frequency of Logging	137
Default Logging Configuration	138
Viewing Data Logs	140
◆ Event Logging	142
ION Event Priority Groups	142
External ION Events	142
Displaying Events	143
◆ Logging and Recording Capacity	144

Data Logging

Your meter ships with a comprehensive data-logging configuration. The data recording frameworks contain Data Recorder modules, Waveform Recorder modules, and Periodic Timer modules. Data Recorder and Waveform Recorder modules are responsible for logging the power system data. The Periodic Timer modules control the recording frequency of the recorder modules to which they are linked.

To learn more about these modules, consult the *ION Reference*.

CAUTION

Changing logging settings will reset logged values. Ensure that all important data has been recorded before you make changes.

Refer to the section “Default Logging Configuration” for detailed information about your meter’s pre-configured Data Recorder modules.

Configuring Data Logging

Use ION software to change your meter’s logging settings.

Using the Front Panel

You cannot configure Logging using the front panel.

Using ION Setup

The Logging Setup Assistant helps you configure meter data logging.

1. Open ION Setup and connect to your meter, using Basic Mode.
2. In the Setup Assistant, navigate to the Logging folder.

Use the three screens (Memory, Revenue Log and EnergyDemand Log) to configure various logging settings.

Memory Screen

3. Select the Memory screen to re-allocate meter memory.

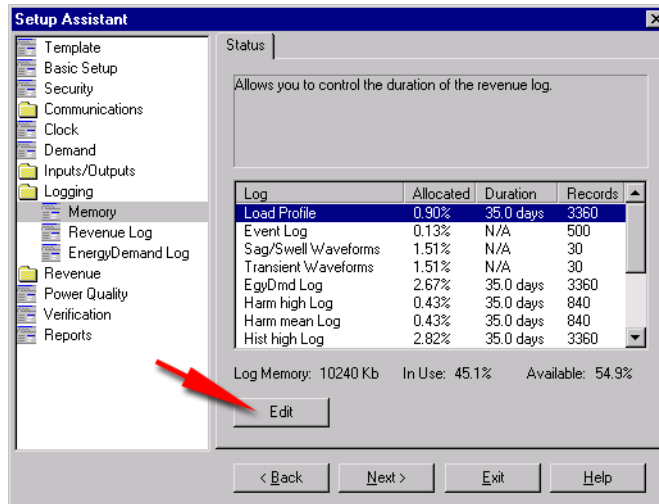

4. Select the Log you wish to configure and click Edit. You can change both the Log Duration (days) and the Log Size (records). Notice how changing these parameters affects the meter memory allocated to that log.

Revenue Log Screen

5. Select the Revenue Log screen to configure Data Recorder #1 (the Revenue Log).

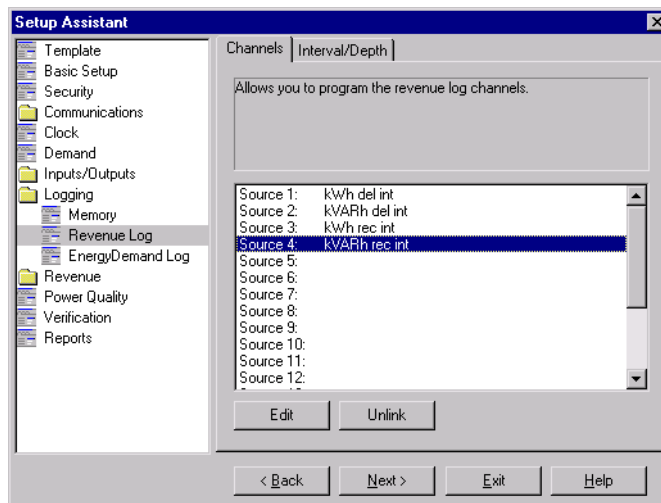

6. Click the Channels tab to edit, link and unlink revenue parameters.
7. Click the Interval/Depth tab to edit the interval and duration of the revenue log.

EnergyDemand Log Screen

- Select the EnergyDemand Log screen to configure Data Recorder #10 (Energy Demand Log).

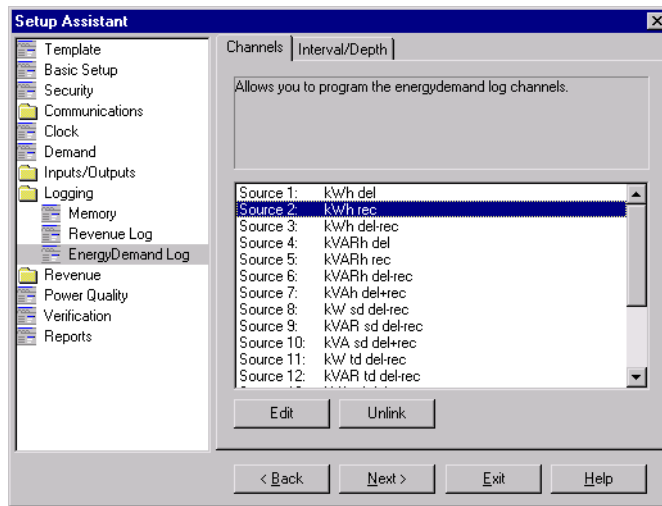

- Click the Channels tab to edit, link and unlink energy/demand log parameters.
- Click the Interval/Depth tab to edit the interval and duration of the energy/demand log

Changing the Parameters that are Logged

The meter's factory configuration logs a comprehensive set of energy, power and harmonics parameters. You cannot change which parameters are logged by configuring a setup register. If you are comfortable editing module links, you can change the logged parameters by linking the output registers you want logged to the inputs of an Data Recorder module.

NOTE

Adding or deleting a log's parameters is an advanced procedure, as it requires changes to the links between modules; use Designer (refer to the Designer section of the online *ION Enterprise Help*) or ION Setup.

Changing Waveform Recording

The Waveform Recorder modules do not require changes to their default settings. If you want to change the format of the recorded waveforms, refer to the Waveform Recorder module description in the *ION Reference*.

Default Logging Capacity

The following table summarizes the default recording depths and recording intervals of the various Data recorders and Waveform recorders in the meter.

 **NOTE**

Default logging depth is set differently for 5 MEG on-board memory (“one-month”) and 10 MEG (“three-month”) option meters. See below.

Data Recorder Number	Log Name	Depth		Interval
		5 MEG	10 MEG	
1	Revenue Log	3360 (35 days)	9120 (95 days)	900 seconds (15 minutes)
9	Loss Log	3360 (35 days)	9120 (95 days)	900 seconds (15 minutes)
2, 3, 4	Historic Logs (3 data recorders)	3360 (35 days)	9120 (95 days)	900 seconds (15 minutes)
7, 8	Harmonics Logs (2 data recorders)	840 (35 days)	2280 (95 days)	3600 seconds (1 hour)
N/A	Waveform recording (waveform recorders: 8 for ION 7550, 16 for ION 7650)	30	30	Triggered on demand
10	Report Generator Log (EgyDmd Log)	3360 (35 days)	9120 (95 days)	900 seconds (15 minutes)
5	Sag/Swell Log	100	100	Triggered on demand
6	Transient Log	100	100	Triggered on demand
N/A	Event Log (Event Log Controller module)	500	500	Triggered on demand
11 - 32	EN50160 Logs (22 data recorders) (ION 7650 with EN50160 ordering option only)	Varies ¹	Varies	Daily, weekly, 10 minutes, ...

¹ See the *Power Quality: ION Meters and EN50160* technical note for more details.

Changing the Log Depths

Change the value in the Data Recorder’s *Depth* setup register to increase the number of records stored in the recorder. The *RecordMode* setup register controls how the Data Recorder will overwrite old records; refer to the Data Recorder module description in the *ION Reference* before changing this setup register.

Changing the Frequency of Logging

The five Periodic Timer modules that control the frequency of different data recording are as follows:

- ◆ “Revenue Log Trg” controls the frequency of the logging of revenue values
- ◆ “Loss Log Trg” controls the frequency of Loss Compensation Data logging
- ◆ “EgyDmd Log Trg” controls the frequency of logging for the Energy and Demand Log (this log is used for generating reports using Reporter)
- ◆ “Hist Log Trg” controls the frequency of Historic Data logging
- ◆ “Harm Log Trg” controls the frequency of Harmonics logging

⚠ CAUTION

The life of the flash memory is estimated at 40 to 50 years of read/writes under normal conditions. If the meter is programmed to write the data recorders in very short intervals, the life of the flash memory will be significantly reduced.

Change the value in the *Period* setup register to change the frequency of data logging (Period values are specified in seconds).

Default Logging Configuration

The following sections describe each Data Recorder and the parameters it logs.

Revenue Log

The *Revenue Log* is configured for use with UTS MV-90 billing software. The default values logged by the Revenue Log are as follows:

Parameter	Description
kWh del int	Interval kWh delivered
kWh rec int	Interval kWh received
kVARh del int	Interval kVARh delivered
kVARh rec int	Interval kVARh received

Historic Data Logging

Three data recorders are used to record standard power system quantities, such as phase current, phase voltage and power factor. These recorders are labeled *Hist Mean Log*, *Hist High Log*, and *Hist Low Log*. By default, they log the following ION output register values:

Hist Mean Log	
Vll ab mean	I avg mean
Vll bc mean	I 4 mean
Vll ca mean	kW tot mean
Vll avg mean	kVAR tot mean
V unbal mean	kVA tot mean
Ia mean	PF lag mean
Ib mean	PF lead mean
Ic mean	Freq mean

Hist High Log	
Vll ab high	I avg high
Vll bc high	I 4 high
Vll ca high	kW tot high
Vll avg high	kVAR tot high
V unbal high	kVA tot high
Ia high	PF lag high
Ib high	PF lead high
Ic high	Freq high

Hist Low Log	
Vll ab low	I avg low
Vll bc low	I 4 low
Vll ca low	kW tot low
Vll avg low	kVAR tot low
V unbal low	kVA tot low
Ia low	PF lag low
Ib low	PF lead low
Ic low	Freq low

Loss Log

The *Loss Log* recorder is configured to record loss values. By default, it logs the following ION parameters:

Parameter	Description
MU Ia ^ 2h int	Phase A interval current squared hours
MU Ib ^ 2h int	Phase B interval current squared hours
MU Ic ^ 2h int	Phase C interval current squared hours
MU VII ab ^ 2h int	Phase A interval voltage Line-to-Line squared hours
MU VII bc ^ 2h int	Phase B interval voltage Line-to-Line squared hours
MU VII ca ^ 2h int	Phase C interval voltage Line-to-Line squared hours

Harmonics Logging

Two recorders provide various harmonics logs, including K-factor and Total Harmonics Distortion (THD). These recorders are labeled *Harm Mean Log* and *Harm High Log*. By default, they log the following ION output register values:

Harm Mean Log		Harm High Log	
V1 THD mean	I1 K Fac mean	V1 THD high	I1 K Fac high
V2 THD mean	I2 K Fac mean	V2 THD high	I2 K Fac high
V3 THD mean	I3 K Fac mean	V3 THD high	I3 K Fac high
I1 THD mean		I1 THD high	
I2 THD mean		I2 THD high	
I3 THD mean		I3 THD high	

ION Enterprise Reporting

One recorder is configured to provide power system data for the Reporter software. This recorder is labeled *Egy Dmd Log*. If any input links to this module are changed, Reporter will not be able to create reports from the device's logs. If you use Reporter, do not change the parameters that are logged in the *Egy Dmd Log*.

Sag/Swell and Transient Logging

The meter logs the following ION output register values:

Sag/Swell Log			
DistDur	DistV2Engy	DistV1Engy	DistV3Engy
DistV1Min	DistV3Min	DistV2Min	DistNominal
DistV1Max	DistV3Max	DistV2Max	SwellLim
DistV1Avg	DistV3Avg	DistV2Avg	SagLim

Transient Log			
TranV1Dur	TranNominal	TranV2Max	PT Sec
TranV1Max	Threshold	TranV3Dur	CT Prim
TranV2Dur	PT Prim	TranV3Max	CT Sec

EN50160 Compliance Logging (ION 7650 with EN50160 ordering option only)

By default, 22 Data Recorders are used for logging EN50160 compliance parameters.

Data Recorder	EN50160 Component Logged	Data Recorder	EN50160 Component Logged
EN50160 Frq/Mg	Power Frequency and Supply Magnitude	EN50160 Vunbal	Voltage Unbalance
EN50160 Flicker	Flicker	EN50160 Hrm Vlt	Harmonics (up to 40th)
EN50160 Vlt Dp1	Supply Voltage Dips	EN50160 lhm Vlt	
EN50160 Vlt Dp2		EN50160 MSignal	Mains Signalling Voltage
EN50160 Vlt Dp3		EN50160 Prm-f/V	Parameter data These data recorders are disabled by default (see below).
EN50160 Vlt Dp4		EN50160 Prm-Flk	
EN50160 Vlt Dp5		EN50160 Prm-VDp	
EN50160 Intrp	Short/Long Interruptions	EN50160 Prm-Vlr	
EN50160 Ovrvlt1	Temporary Overvoltages	EN50160 Prm-OV	
EN50160 Ovrvlt2		EN50160 PrmHrm1	
EN50160 Ovrvlt3		EN50160 PrmHrm2	

The ION 7650 logs EN50160 counter data for present and previous observation periods. EN50160 events are also logged. EN50160 parameter data logging (from seven "Prm" data recorders) is disabled by default. The EN50160 Parameter Logging enable is accessible in the default Power Quality Vista diagram.

For more information about EN50160 data logging, refer to the technical note *Power Quality: ION Meters and EN50160*.

Viewing Data Logs

See the Report chapter. You can also view Data Logs using ION Setup.

1. Open your meter in ION Setup, using Basic Mode.
2. Navigate to View > Data Screens > Data Recorders. The following logs are available for viewing:
 - ◆ Average Harmonics
 - ◆ Energy & Demand
 - ◆ Historic Average, Historic Highs, Historic Lows

- ◆ Maximum Harmonics
- ◆ Revenue Log
- ◆ Sags & Swells
- ◆ Transformer Losses
- ◆ Transients (ION 7650 only)

Event Logging

Events produced by a meter's various ION modules are prioritized and grouped to facilitate custom logging. Each event is assigned a priority group number based on its type and severity.

ION Event Priority Groups

Some event groups are preset with a Priority Number as shown in the table below. You can also define your own priority number for some modules. Priority numbers from 128-191 appear in the global event log viewer in ION Enterprise software. Priority numbers from 192-255 are logged, initiate a beep and cause the window to flash. You can customize these responses to display messages or perform *net send* messages, for example.

Event Group	Description	Priority Number
Reset	Module reset or re-synchronized	5
Setup Change	Module setup changes (setup register changes, label changes, input handle changes)	10
Input Register Change	Inputs of certain modules change value (ie, input to And/Or module changes)	15
I/O State Change	I/O state changes (ie, relay closes)	20
Information	Module produces important user information	25
Warning	Module produces a warning	30
EN50160 Event (ION 7650 with EN50160 ordering option only)	An EN50160 Counter (N ₁ or N ₂) increases	50
Failure	A failure has occurred	255
Setpoint	Setpoint condition goes Active or Inactive (ie, Sag/Swell module detects a disturbance)	programmable via module setup

The Event Log Controller module allows you to set a priority cutoff for event logging. Any events with a priority number greater than the cutoff value are logged, and events with lower priorities are discarded. Refer to the individual module descriptions and the Event Log Controller module description in the *ION Reference* for more details.

External ION Events

Some events are not produced by a specific module. These events are generated internally by the meter. Their associated priority levels are shown in the table below.

Event Group	Description	Priority Number
Warning	Factory initialize performed	30
	Firmware or memory upgrade performed	
	Meter power-up or power-down	
	Internal modem not responding or modem recovered	
	Battery low	
	Telnet or serial terminal locked out	
	Security disabled or enabled	
Failure	Communications fail to allocate required memory	255

Displaying Events

View Events in the following locations:

Application	Menu / Screen	Navigation
Front Panel	Event Log	Press Events softkey
ION Setup	Event	Display Mode > Data Recorders folder > Event
Vista	Meter Events	System & Logs tab > Meter Events object
WebMeter	N/A	N/A

Logging and Recording Capacity

The meter provides both data and event logs. The amount of memory required to store these logs depends on the number of parameters being logged and the frequency with which these parameters are logged.

The following equation can help determine the amount of memory required to store **data and event logs**:

$$\text{each record consumes (in Bytes)} = [(\text{number of parameters} * 5) + 8]$$

The meter can also perform waveform recording. It can simultaneously capture events on all channels to a maximum of 96 cycles each.

To calculate the **waveform memory** usage use the following formula:

$$\text{waveform memory usage (in Bytes)} = [2 * (\text{number of samples per cycle}) + 10] * (\text{number of cycles in waveform}) + 30$$

NOTE

Round up to the next kilobyte after each of the above calculations.



chapter
13

Revenue

This chapter provides instructions for configuring transformer line loss compensation and time of use.

In This Chapter

◆ Transformer Line Loss Compensation (TLC)	146
Configuring TLC	146
Using the Front Panel	146
Using ION Setup	146
Using Vista	147
◆ Time of Use	148
Configuring Time of Use	148
Using the Front Panel	148
Using ION Setup	148
Using Designer	148
Time Of Use Module Settings	149
Seasonal Settings	149
Creating a New Time Of Use Schedule	150
Displaying Time of Use	150

Transformer Line Loss Compensation (TLC)

Loss Compensation is used when a meter's actual location is different from the electrical location where change of ownership occurs; for example, where meters are connected on the low-voltage side of power transformers when the ownership change occurs on the high-side of the transformer. This physical separation between meter and actual billing point results in measurable losses. Compensating for this loss - Loss Compensation - is the means of correcting this meter reading. Losses may be added to or subtracted from the meter registration.

Meters are usually installed on the low-voltage side of a transformer because it is more cost-effective. There are also cases where change of ownership may occur halfway along a transmission line where it is impractical to install a meter. In this case, power metering must again be compensated.

CAUTION

Due to the variation in installations, advanced knowledge of power systems and connection methods is required before transformer loss compensation can be properly implemented. Data parameters should only be programmed by qualified personnel that have appropriate training and experience with Transformer Loss Compensation calculations.

For more information, see the latest version of the *Transformer Line Loss Compensation* technical note.

Configuring TLC

Use ION software to change your meter's TLC settings.

Using the Front Panel

You cannot configure Transformer Line Loss Compensation using the front panel.

Using ION Setup

The Revenue Setup Assistant helps you configure TLC. The Transformer Loss screen allows you to enable/disable TLC, choose which method you prefer (1 or 2) and configure TLC settings.

1. Open ION Setup and connect to your meter, using Basic Mode.
2. In the Setup Assistant, navigate to Revenue > Transformer Loss
3. First, enable TLC by selecting Loss Comp Enable and clicking the Edit button.

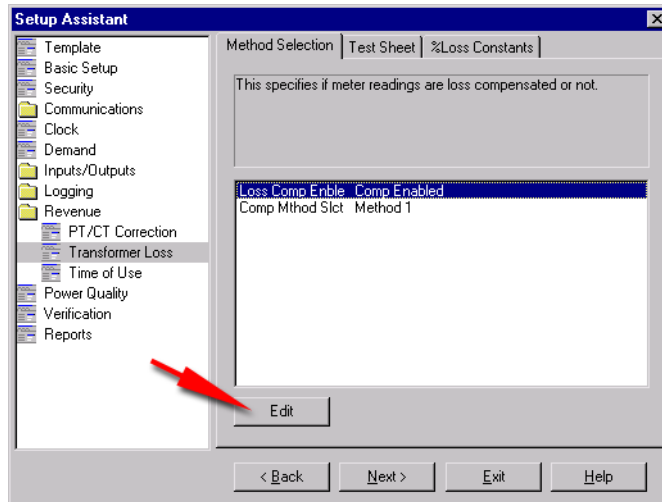

4. Select Comp Enabled from the drop-down list and click OK.
5. Next choose the TLC method you wish to use by selecting Comp Mthod Slct and clicking the Edit button.
Select Method 1 to use the Test Sheet method and Method 2 to use the %Loss Constants method.
6. Finally, click the tab of the TLC method you chose in the previous step and configure the settings for that method.

Using Vista

Open your meter in Vista and click on the System & Logs tab. Click on the Loss Compensation object and configure TLC as required using the Loss Compensation screen. You can also enable/disable TLC and select your method on this screen.

Time of Use

The Time of Use module may only be important if you are using the meter in a billing application (i.e. you are a power provider), as the module contains the meter's seasonal rate schedules. Typically, power consumers do not require Time Of Use configuration.

See the *ION Reference* for more information on the Time of Use module.

Configuring Time of Use

Use ION software to change your meter's Time of Use settings.

Using the Front Panel

You cannot configure Time of Use using the front panel.

Using ION Setup

The Time of Use Setup Assistant helps you configure the Time of Use module.

1. Open ION Setup and connect to your meter, using Basic Mode.
2. In the Setup Assistant, navigate to Revenue > Time of Use

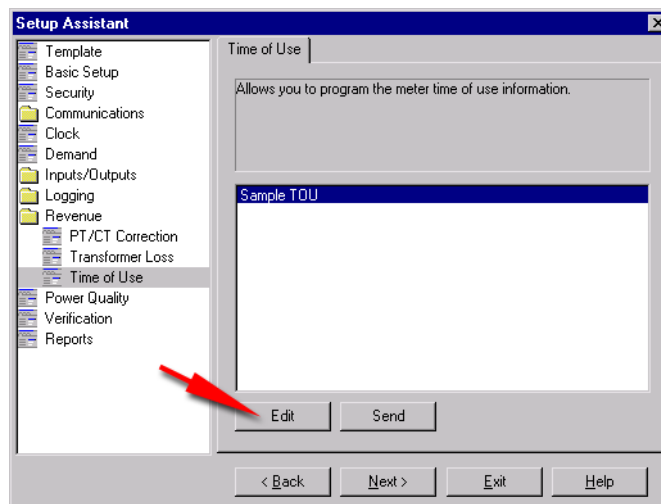

3. Select a Time of Use program from the list (in this example, Sample TOU) and click Edit.
4. Follow the Time of Use Wizard to configure your program. Click Send to save the TOU program on your meter.

Using Designer

Open your meter in Designer and navigate to the Time-of-Use Setup Framework. Right-click the Time of Use module to edit.

Time Of Use Module Settings

The Time of Use module's setup registers define your seasons' start and end dates, the day types where your rates may differ, and the rate schedules for each season's day types. The module compares the meter's internal clock with the season, day, and time of day settings in these registers, and changes its output registers to reflect the current state of these settings.

Seasonal Settings

The Time of Use module supports up to four separate seasons. Each seasons' start and end dates are set into the appropriate *Season* setup register.

NOTE

Ensure that there is no date overlapping when defining seasons and that every day of the year is covered by your seasons. If there are gaps between seasons, the module returns an error and will not function.

If your rates do not change between seasons, you do not need to configure the *Season* setup registers — Season 1 is the default, and all Season 1 rates are in effect all year.

If you have different seasons, enter their start and end dates into the appropriate setup registers. If your season is active on the same dates every year, you only need to enter a single range of dates in the appropriate *Season* setup register. If the active dates are different each year (for example, Season 3 becomes active every first Monday in August), the start dates must be individually specified for each year.

The Time of Use module is partially configured at the factory. Check the setup registers to ensure that the settings match your Time of Use schedules.

Setup Register	Function
Season 1 - 4	These setup registers define the dates for each active season. When a season is active, the Time of Use module will use the applicable rate schedules.
Season 1 - 4 Weekday Rates	These setup registers specify seasonal weekday rates.
Season 1 - 4 Weekend Rates	These setup registers specify seasonal weekend rates.
Season 1 - 4 Alt 1 Rates	These setup registers specify a season's daily rates during the days specified in the Alt 1 Days setup register.
Season 1 - 4 Alt 2 Rates	These setup registers specify a season's daily rates during the days specified in the Alt 2 Days setup register.
Season 1 - 4 Holiday Rates	These setup registers specify a season's daily rates during the days specified in the Holidays setup register.
Weekdays	This register defines the days of the week for all seasons. The rates in the Season (1, 2, 3, or 4) Weekday Rates setup registers are used on these days.
Weekends	This register defines the weekend days for all seasons. The rates in the Season (1, 2, 3, or 4) Weekend Rates setup registers are used on these days.

Setup Register	Function
Alt 1 Days	This register defines a set of alternative dates for all seasons. These dates generally have different rates from weekdays, weekends, or holidays.
Alt 2 Days	This register is similar in function to Alt 1 Days, but contains a different set of dates.
Holidays	This register defines the holidays for all seasons. The rates defined in the Season (1, 2, 3, or 4) Holiday Rates setup registers are used on these days.
Self Read Days	This setup register defines the dates and times that the Self Read output register will pulse. If no time is entered in this register, the Self Read output register will pulse on the date specified at 12:00 AM.

Creating a New Time Of Use Schedule

You can create a new TOU schedule using the TOU Program Manager; the program is a self-documented, graphical wizard. You launch the TOU Program Manager in Designer from the Options menu.

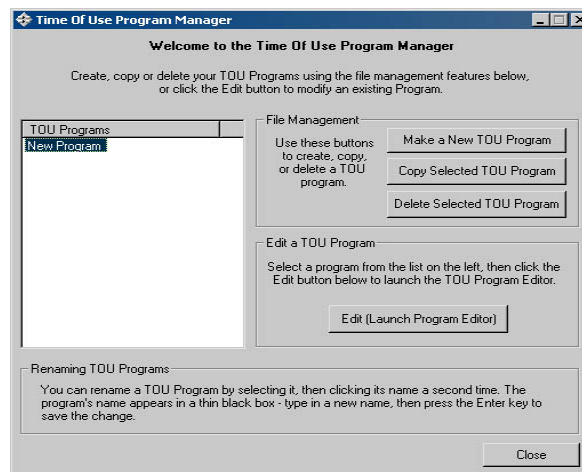

Displaying Time of Use

View Time of Use values in the following locations:

Application	Menu	Navigation
Front Panel	TOU, TOU Egv, TOU Dmd1 and TOU Dmd2 screens	Press the applicable softkey
ION Setup	N/A	N/A
Vista	Time of Use Screen	Revenue tab > Time of use object
WebMeter	N/A	N/A



chapter
14

Power Quality

This chapter explains how to configure your meter's power quality functionality.

In This Chapter

◆ Introduction	152
◆ Configuring Power Quality	152
Using the Front Panel	152
Using ION Setup	153
Using Designer	154
Sag/Swell Module Settings	154
Transient Module Settings (ION 7650 only)	155
EN50160 Settings (ION 7650 with EN50160 only)	155

Introduction

Power quality configuration is provided by a number of modules, depending on your meter type: the Sag/Swell module, the Transient module (ION 7650 only), and numerous EN50160 frameworks (ION 7650 with EN50160 ordering option only), some of which include the Mains Signalling Evaluation modules.

See the *ION Reference* for more information on these modules.

Configuring Power Quality

Use the front panel or ION software to change your meter's power quality settings.

Using the Front Panel

The PQ Setup screen contains the following settings for the detection voltage sags and swells (i.e. ITI CBEMA Type 2 and Type 3 disturbances).

Menu	Setting	Description	Range (Values)	Default
PQ SETUP	SWELL LIMIT	Specifies the magnitude above which a power system input must rise for a swell to be recorded	100 to 1000	106
	SAG LIMIT	Specifies the magnitude below which a power system input must fall for a sag to be recorded	0 to 100	88
	CHANGE CRITERIA	Specifies the amount by which an input must change during a disturbance to be considered a new sub-disturbance	0 to 100	10
	NOMINAL VOLTAGE	Specifies the nominal voltage of the power system	0 to 1,000,000	0
	EVENT PRIORITY	Assigns a priority level to sag/swell events	0 to 255 (255 is highest priority)	200

Swell Limit

This value must be expressed as a percentage of the nominal voltage (entered below in the NOMINAL VOLTAGE item). Setting the SWELL LIMIT value changes the *Swell Lim* setup register in the factory-configured Sag/Swell module.

Sag Limit

This value must be expressed as a percentage of the nominal voltage (entered below in the NOMINAL VOLTAGE item). Setting the SAG LIMIT value changes the *Sag Lim* setup register in the factory-configured Sag/Swell module.

Change Criteria

You do not need to change this value for normal operation. This value must be expressed as a percentage of the nominal voltage (entered below in the NOMINAL VOLTAGE item).

For example, if your Nominal Voltage is 120 V and your Change Criteria is 10%, any voltage change of 12 V or more during a disturbance will cause a new sub-disturbance to be recorded. Setting the CHANGE CRITERIA value changes the *ChangeCrit* setup register in the factory-configured Sag/Swell module.

Nominal Voltage

By default, this value is set to 0 V. Ensure that this item matches your power system's nominal voltage (i.e. 120, 277, or 347). All Sag/Swell functions are disabled when the nominal voltage setting is 0 (zero). Setting the NOMINAL VOLTAGE value changes the *Nom Volts* setup register in the factory-configured Sag/Swell module.

CAUTION

For the ION 7650 only, the value you enter will also be used by the Transient module and in all EN50160 compliance calculations (if applicable). All EN50160 and Transient functions are disabled when the NOMINAL VOLTAGE setting is 0 (zero).

Event Priority

You do not need to change this value for normal operation. Setting the EVENT PRIORITY value changes the *EvPriority* setup register in the factory-configured Sag/Swell module.

Using ION Setup

The Power Quality Setup Assistant helps you configure the various power quality modules.

1. Open ION Setup and connect to your meter, using Basic Mode.
2. In the Setup Assistant, navigate to the Power Quality folder.

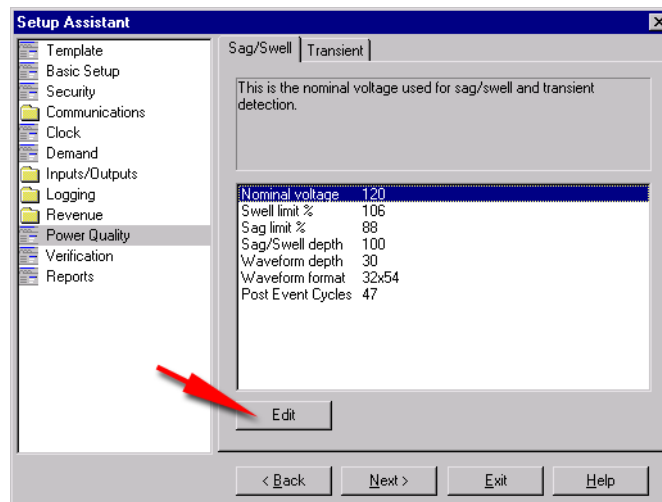

3. Click on the Sag/Swell tab to set sag and swell limits, configure sag/swell waveform recorder settings and most importantly, record your system's nominal voltage.
4. Click on the Transient tab to configure various settings such as voltage deviation threshold and transient waveform recorder depth and frequency.

Using Designer

Open your meter in Designer and navigate to the Power Quality Setup Framework. Right-click a module to edit.

Sag/Swell Module Settings

The Sag/Swell module monitors voltage waveforms for sags and swells (i.e. ITI (CBEMA) Type 2 and Type 3 disturbances); it then reports each disturbance's magnitude and duration. The Sag/Swell module can also detect sub-disturbances during a Sag/Swell event. Settings are as follows:

Setup Register	Function	Default
Swell Lim	This is the magnitude above which a voltage deviation is considered a swell.	106
Sag Lim	This is the magnitude below which a voltage deviation is considered a sag.	88
Change Crit	This is the amount a voltage signal must change during a disturbance to be considered a new sub-disturbance.	10
Nom Volts	This is the nominal power system voltage (used for all Power Quality functions).	0 ¹
EvPriority	The priority assigned to Sag/Swell and Transient module events (0 to 255, 255 is highest).	200

¹ The primary power system voltage is sometimes different than the PT Primary setup register value (i.e. when the PT Primary is used to indicate winding ratio rather than primary voltage).

Besides *NomVolts*, the only setup registers that you may need to change in the Sag/Swell module are *Swell Lim* and *Sag Lim*. Most applications are served by the default values entered into these registers. The *Change Crit* and *EvPriority* setup registers do not need to be changed for normal operation.

NOTE

If the Sag/Swell module's *Nom Volts* setup register is set to zero, all Sag/Swell module functions are disabled. *Nom Volts* is typically set when the meter is put into service. If *Nom Volts* has not been set, enter a value for your system's nominal voltage (i.e. 120, 277, or 347). The value you enter will also be used by the Transient module and in all EN50160 compliance calculations with the ION 7650.

Transient Module Settings (ION 7650 only)

The Transient module monitors voltage waveforms for transient activity (i.e., ITI CBEMA Type 1 disturbances). The *Threshold* setup register defines what voltage disturbance magnitude should be considered as transient activity. *Threshold* is interpreted as a percentage of the nominal system voltage, plus 100. For example, if you want transients recorded when voltage deviates from nominal by 20%, enter 120 into the *Threshold* setup register.

Setup Register	Function	Default
Threshold	This is the magnitude at which a voltage deviation is considered a transient.	125
EvPriority	The priority assigned to Sag/Swell and Transient module events (0 to 255, 255 is highest).	200

EN50160 Settings (ION 7650 with EN50160 only)

The EN50160 framework is composed of numerous ION module types including: Mains Signaling Evaluation, Harmonics Evaluation, Voltage Harmonics, Flicker, and more.

Refer to the technical note *Power Quality: ION Meters and EN50160* for details.



chapter
15

Test Mode

This chapter describes your meter's Test Mode and explains how to switch from Normal Mode to Test Mode.

In This Chapter

◆ Introduction	158
◆ Switching to Test Mode	158
Using the Front Panel	158
Using Vista	158
Using ION Setup	159
Hardware-locked Meters and Test Mode	160
Test Mode Default Display Screens	160
Test Mode Energy Pulsing	160

Introduction

Test Mode is typically used for verifying meter calibration and function. The meter is usually reading data from a test power supply while these functions are performed.

Several things to note about Test Mode:

- ◆ All of the billing quantities that are recorded when the meter is in normal mode will stop accumulating when the meter is switched to Test Mode — the data is sent to special Test Mode registers instead.
- ◆ The values accumulated in these test registers are displayed on the front panel and in ION software.
- ◆ The regular normal mode billing registers are unaffected while the meter is in Test Mode; accumulation of this data continues as soon as you exit Test Mode.
- ◆ All test registers are reset to zero when you exit Test Mode.

Switching to Test Mode

Place the meter into Test Mode using Vista or ION Setup. The meter's front panel informs you when the meter is in Test Mode with a special Test Mode display screen.

Using the Front Panel

You cannot enter Test Mode using the front panel.

Using Vista

1. Open the meter in Vista.
2. Navigate to Revenue and click the Setup & Controls button in the bottom right-hand corner of the revenue screen.
3. Select the Test Mode radio button. You will be prompted for the ION Enterprise user password. If meter security is enabled, you will also be prompted for the meter password.

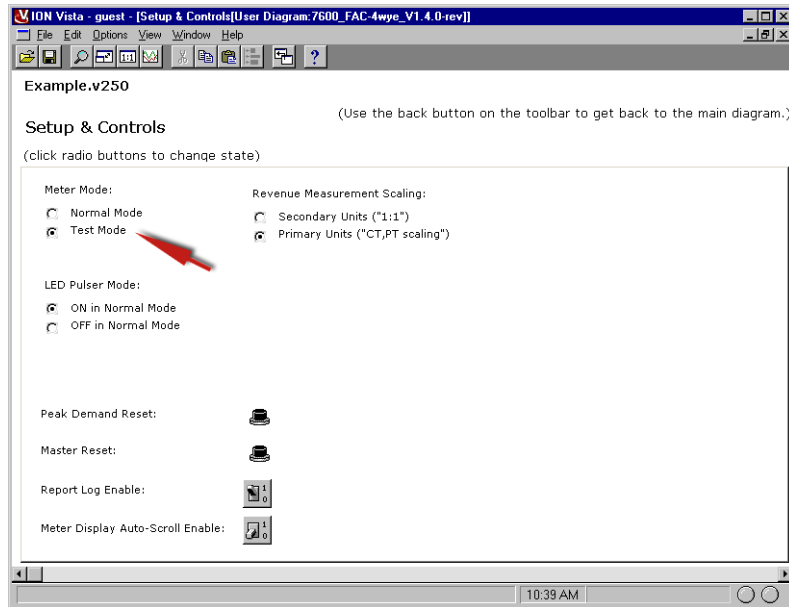

Use this screen to view and reset the registers that accumulate real-time data. For more information see the Vista section of the online *ION Enterprise Help*.

Using ION Setup

1. Open ION Setup and connect to your meter, using Basic Mode.
2. In the Setup Assistant, navigate to the Verification folder.

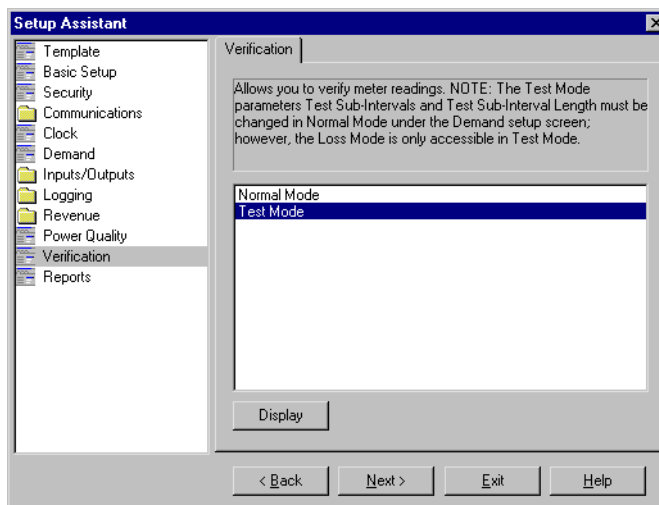

3. Click on Test Mode. If meter security is enabled, you will be prompted for password. A dialog box informs you the meter is in Test Mode.



- Click OK. The Test Mode screen appears and test values are displayed.

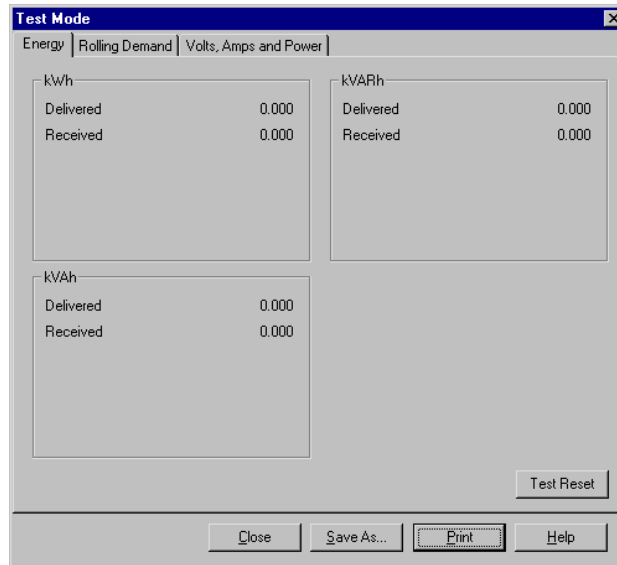

Click on the tabs to perform various test-related tasks. See the ION Setup online help for more information.

- Click Close. A dialog box informs you the meter is back in Normal Mode.



Hardware-locked Meters and Test Mode

Hardware-locked meters must be in Test Mode before they can be configured. To put a hardware-locked meter into Test Mode, you must unlock the meter first. For instructions on locking and unlocking your meter see the *ION 7550 / ION 7650 Hardware Lockable Meter* product option document.

Test Mode Default Display Screens

Recall that the values shown in the Test Mode display screens represent different accumulators than those shown in normal mode (although they perform some of the same basic measurements). The Test Mode display values are for calibration checking purposes; they will only accumulate while the meter is in Test Mode.

Test Mode Energy Pulsing

One digital output (DO4) is factory-configured to pulse while the meter is in Test Mode. The energy pulsing digital output provides an interface for calibration checking instruments.



chapter
16

Meter Resets

This chapter provides instructions for performing various meter resets.

In This Chapter

◆ Performing a Reset	162
Using the Front Panel	162
Factory Menu	162
User Menu	163
Using ION Setup	164
Using Vista	165

Performing a Reset

Resets allow you to clear various accumulated parameters stored by the meter.

 NOTE

Be sure to record any important data before performing a meter reset.

Using the Front Panel

Use the Meter Resets setup menu to perform all available resets. You must enter a valid meter password before executing any meter resets.

Factory Menu

The Factory sub-menu contains the following default resets:

Peak Dmd Rset

The Peak Demand Reset clears the peak demand values logged in the meter. When the meter is in test mode, the Demand Reset object clears the Revenue Test Mode demand parameters. See the Test Mode chapter for more information.

 NOTE

By default, there is a 25 day Demand Lockout Time. This is the minimum time allowed between consecutive demand resets. Any attempts to perform a demand reset before the lockout time has expired will be ignored. See the Demand chapter for details about changing the default Demand Lockout.

MnMx Rset

The Minimum/Maximum Reset clears all accumulated minimum and maximum values stored in the meter.

Harm MnMx Rset

The Harmonics Minimum/Maximum Reset clears all accumulated minimum and maximum harmonics values stored in the meter.

Master Reset

The Master Reset control clears all the cumulative and derived quantities from the meter (including demand, peak demand, energy, revenue, and test mode parameters), clear the meter's event and waveform logs, and reset the meter's Data Recorder modules. A display screen appears, indicating the reset is in progress. Another screen informs you when the reset is complete.

 CAUTION

The Master Reset operation will clear all billable quantities from the meter, all logged data from the meter's event and waveform logs, and all data recorders. Carefully consider the implications of performing a Master Reset before proceeding.

DI Count Reset

The DI Count Reset clears the Digital Input Status Change counter. By default, the number of status changes of each digital input is shown in the *D Inputs* front panel display as well as in the Vista Digital Inputs/Outputs diagram.

User Menu

The User sub-menu contains less critical and user-configurable controls:

Dist Count Rset

The meter contains a voltage disturbance display in its Power Quality Vista diagram, which counts the number of sag/swell events that have occurred since power-up or last reset. The Disturbance Count Reset clears this counter.

Man Wfm Trg

The Manual Waveform Trigger forces the meter to perform a waveform capture. Waveform data is accessible in the Vista Power Quality diagram.

EN50160 Reset (ION 7650 with EN50160 ordering option only)

This item resets all EN50160 parameters and statistics accumulated in the meter. The technical note *Power Quality: ION Meters and EN50160* contains more information about EN50160.

Rst Avlty Stats

This item resets the Power Availability framework. Current values in the Availability display screen - availability (up-time in parts per million), number of nines, and evaluation time (in days).

Custom Trigger

Program this reset with Designer. Refer to “Creating a Front Panel Reset” in the Front Panel chapter for more details.

Using ION Setup

1. Open ION Setup and connect to your meter, using Basic Mode.
2. In the Setup Assistant, navigate to the Verification folder.
3. Select Normal Mode and click Display.

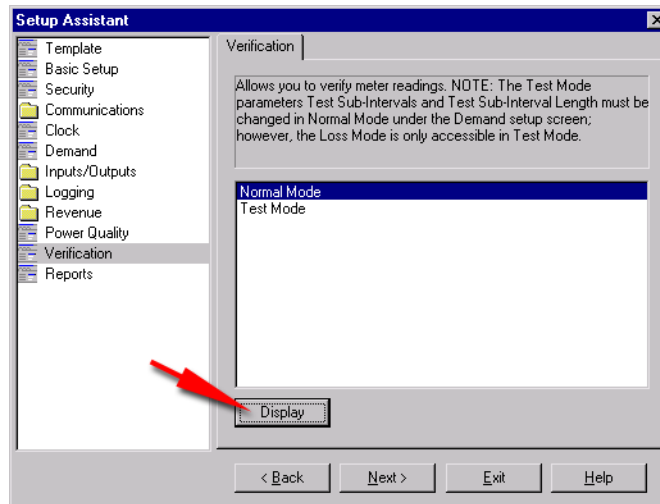

4. Click on various tabs in the Normal Mode dialog box. Three resets are available: Peak Reset, Master Reset and Number of Nines Reset. Click the appropriate button to perform the reset (Peak Demand in the example below).

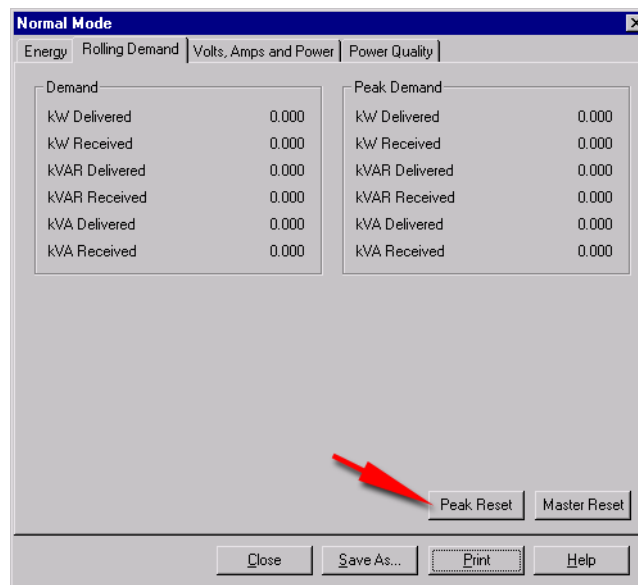

A dialog box informs you when the reset is complete.

Using Vista

Open your meter in Vista. You can perform several resets from within Vista:

Performing a Peak Demand Reset or Master Reset

1. Click the System & Logs tab and click the Setup & Controls object.
2. Click the appropriate reset button to perform the reset.

Performing a Min/Max Reset

1. Click the Volts & Amps tab and click the Long-term Min/Max Measurements object.
2. Click the Min/Max reset button to perform the reset.

Performing a Sag/Swell, Availability or Harmonics Min/Max Reset

1. Click the Power Quality tab and click the Power Quality Controls object.
2. Click the appropriate reset button to perform the reset.



chapter
17

Alerting

ION alerts can send an email or contact a modem, fax, pager, or software in the event of a user-specified condition. These conditions can be changes in relays or power quality problems including surges, sags, swells and outages.

This chapter explains how to configure your meter network for alerting.

In This Chapter

◆ Introduction	168
◆ Configuring the Meter for Alerting	168
Using the Front Panel	168
Using ION Setup	168
Using Designer	168
Alerting ION Software via the Alarm Server	169
Remote Site Event Notification	169
Alerting via an Alphanumeric Pager	169
Alerting via a Numeric Pager	170
Alerting via Email	171

Introduction

The meter's Alert module sends an alert whenever its *Trigger* input is pulsed. You can connect this input to any module that produces a pulse output. You can use modules that monitor alarm conditions such as changes in relay status and power quality problems. For example, you can connect the *Trigger* input to the output of a Setpoint module, thereby allowing the Alert module to send an alert when the setpoint condition is reached.

The Alert module delivers these types of alerts:

- ◆ Numeric Pager
- ◆ Alphanumeric Pager
- ◆ PEGASYS (for alerts to PEGASYS software)
- ◆ ION Alert (for alerts to ION Enterprise software)
- ◆ ASCII
- ◆ Email

Selection between modes is made with the Alert module *Alert Type* setup register.

The Alert module requires access to either a modem (a dedicated modem or a modem handling a loop of meters) or Ethernet (for the Alert module email capabilities).

Your meter has no pre-configured Alert framework. For detailed information about alerting, including how to build a framework to send alerts, refer to the Alert module description in the *ION Reference*.

Configuring the Meter for Alerting

Use ION software to change your meter's alert settings.

Using the Front Panel

You cannot configure Alerting from the front panel.

Using ION Setup

1. Connect to your meter in ION Setup, using Advanced Mode.
2. Click on an Alert module to edit.

Using Designer

1. Create a new Alert module by dragging one from the Toolbox.
2. Right-click on the module to configure.

Alerting ION Software via the Alarm Server

NOTE

For detailed information about sending alerts to ION Enterprise/PEGASYS software via the Alarm Server, refer to the ION Enterprise online help.

The Alarm Server can run on any ION software Primary or Secondary server. The server computer should have a dedicated phone line and modem. Modems at remote sites are programmed to dial the server's phone number when a priority event occurs. The Alarm Server monitors the phone line and waits for the remote sites to announce events. The most common use of the Alarm Server is to handle Remote Site Event Notification.

Remote Site Event Notification

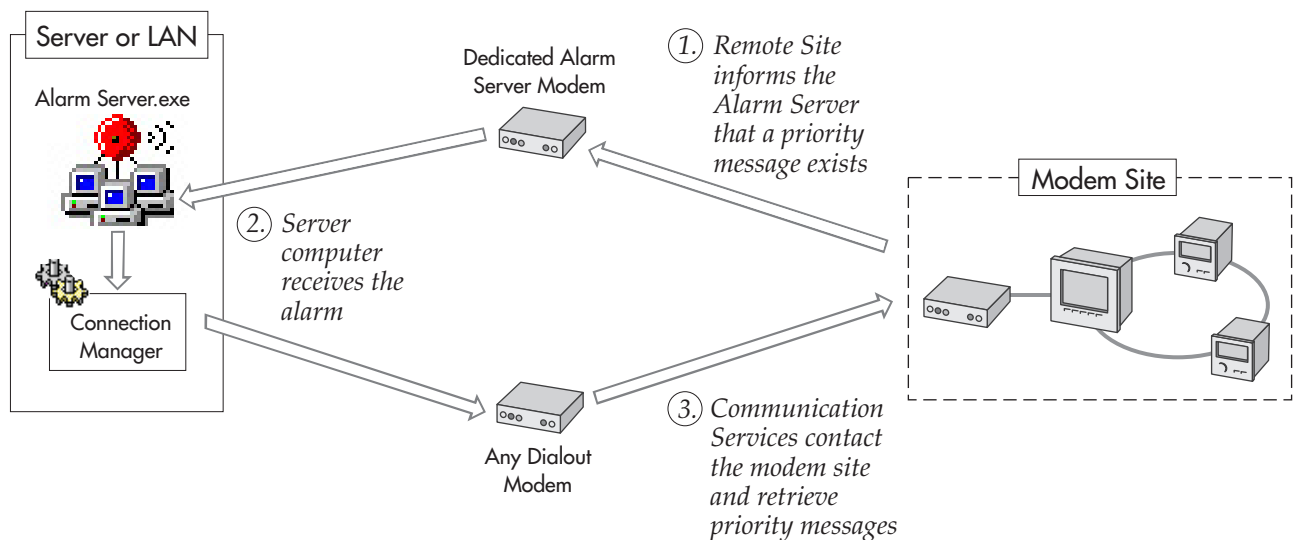

The Alarm Server uses a series of command line arguments to specify the actions it takes when a priority event is reported. These commands must be entered on the computer that is running the Alarm Server utility. Typically the Alarm Server is configured to launch the Connection Manager, which dials up the remote site and retrieves the logs from the devices. The Alarm Server can also be configured to launch other applications. A series of parameter switches are added to the command line to pass information about the event to the application that is launched.

Alerting via an Alphanumeric Pager

NOTE

For detailed information about building a framework for alerting via an alphanumeric pager, refer to the Alert module description in the *ION Reference*.

If an alphanumeric pager is specified as the destination address in the Alert module, then an alphanumeric paging service receives a message from the ION meter.

Once the modem at the paging service is contacted, the ION meter transmits the following information:

- ◆ Pager identification number
- ◆ Local time (year, month, date, hours, minutes, seconds)
- ◆ Remote site identification
- ◆ Priority of the alarm
- ◆ Alert message, with text strings and realtime measured values

To include a module's *Source* input in the message, reference the message string by using the form %Vn, where n is the *Source* input number. In the following *Message* register setting, the kWtot value is %V1. The string includes *Source* input 1 which would be the kWtot register from the Power Meter module.

The destination register contains your modem access number for the paging service provider and is what is dialed out first. The *Pager Num* register is the pager access number that is provided by your paging company.

Alerting via a Numeric Pager

NOTE

For detailed information about building a framework for alerting via a numeric pager, refer to the Alert module description in the *ION Reference*.

If a numeric pager is specified as the destination address in the Alert module, then a numeric paging service receives a message from the ION meter. Due to the inherent limitations in numeric paging, the ION meter can only send a string of digits to the paging service. The Alert module then waits a specified time, determined by the number of commas inserted after the phone number in the *Pager Num* setup register. Finally, the Alert module dials the message digital string.

There are two important factors to consider when setting up the Alert module for numeric paging. First, be sure to specify a string of digits that is meaningful to you, such as a coded message. Second, be aware that there is no way to assure that a message has been successfully transmitted. Instead, there may be a busy signal or an answering machine may take the call. The number of commas you add to your dial string is an estimate of how long the modem at the remote site waits before it transmits numbers.

NOTE

In the following destination-setting example: 1-250-555-666,,,,,999#, the pager number is 1-250-555-666 and the message string that displays on the pager is 999. You may need to insert 9,,, before the destination number if the line you are using is not a direct line. In this case the destination number is 9,,1-250-555-666,,999#

Alerting via Email

NOTE

For detailed information about setting up your network and building a framework for meter email (MeterM@il) alerts, refer to the technical note *MeterM@il Internal Email Client Feature*.

If email is specified as the destination address in the Alert module then an email message is sent to any address you specify. You can only set one email address per Alert module. If you want to send an alert to more than one email address you need to create a group — be sure your email server is configured to send email to groups via SMTP (Simple Message Transport Protocol).

Follow the steps below to send email alerts from your meter. Note that your meter must support emailing (with a correctly configured SMTP server):

1. Create an Alert module.
2. Configure these Alert module setup registers as indicated:
 - ◆ *Message* – type in the text of the alert to be emailed.
 - ◆ *Destination* – type in the destination email address.
 - ◆ *Type* – select Email.
 - ◆ *Com Port* – select Ethernet.
 - ◆ *Location* – type in a custom string; this is optional, and appears in the email.
 - ◆ *Email From* – type in an address that you want the email to appear from. This may be required as some SMTP servers only accept emails from valid addresses.
3. Create an ION module that will produce a pulse on its *Trigger* output when the exceptional event occurs (for example, a Setpoint module pulses its *Trigger* output when the setpoint condition is reached).
4. Link the Alert module's *Trigger* input to the *Trigger* output of the module created in step 3.
5. Send and save. When the *Trigger* input is pulsed, the Alert module establishes communications with the SMTP mail server, and emails the alert message.



chapter
18

Setpoints

This chapter provides instructions for configuring meter setpoints.

In This Chapter

◆ Introduction	174
◆ Configuring Setpoints	174
Using the Front Panel	174
Using ION Setup	174
Using Vista	174
Relative Setpoint Module Settings	175
Fine Tuning Over Condition Monitoring	175

Introduction

The Relative Setpoint module provides extensive control, secondary protection, and analysis capabilities by allowing you to initiate an action in response to a specific condition. It is particularly useful for performing actions based on differences between a value (e.g. kW on phase A) relative to a reference value (e.g. kW demand for all three phases). Use this module's outputs for demand control of equipment or any other applications requiring setpoint activity relative to a varying value. See the *ION Reference* for more information on the Relative Setpoint module.

Configuring Setpoints

Use ION software to change your meter's setpoints.

Using the Front Panel













You cannot configure Setpoints using the front panel.

Using ION Setup

1. Connect to your meter in ION Setup, using Advanced Mode.
2. Click on the Relative Setpoint module you wish to configure.

Using Vista

Open your meter in Vista, and click on the Setpoints tab. Click the Setup grouping object. Use the switches to turn various monitoring on and off (see circled below). Click the numeric boxes to edit condition settings.

<p>Over kW SWDemand</p> <p>Annunciate if the total kW SWDemand exceeds <input type="text" value="0"/> kW</p> <p>Enable Over Demand Setpoint  Click to change value, then press Enter</p>	<p>Status  Demand <input type="text" value="1 kW"/></p>
<p>Over Current on phase A,B,C</p> <p>Annunciate if the current on phase A exceeds <input type="text" value="0"/> A</p> <p>Annunciate if the current on phase B exceeds <input type="text" value="0"/> A</p> <p>Annunciate if the current on phase C exceeds <input type="text" value="0"/> A</p> <p>Annunciate if I 4 exceeds <input type="text" value="0"/> A</p> <p>Annunciate if I 5 exceeds <input type="text" value="0"/> A</p> <p>Over I a,b, </p> <p>Over I 4 </p> <p>Over I 5 </p>	<p>Status</p> <p> I a <input type="text" value="4 A"/></p> <p> I b <input type="text" value="5 A"/></p> <p> I c <input type="text" value="4 A"/></p> <p> I 4 <input type="text" value="0 A"/></p> <p> I 5 <input type="text" value="0 A"/></p>
<p>Over Voltage unbalance</p> <p>Annunciate if the Voltage unbalance exceeds <input type="text" value="0"/> %</p> <p>Enable Over Vunbal Setpoint </p>	<p>Status  V unbal <input type="text" value="0.1 %"/></p>

Relative Setpoint Module Settings

The Relative Setpoint modules monitor the following for “over” conditions: phase current, kW demand, and voltage unbalance.

Module	Label	Description
Relative Setpoint 1	Over KW sd	When active, this annunciates when the total kW SWDemand exceeds a specified amount.
Relative Setpoint 2	Over I a	When active, this annunciates when the current on phase A exceeds a specified amount.
Relative Setpoint 3	Over I b	When active, this annunciates when the current on phase B exceeds a specified amount.
Relative Setpoint 4	Over I c	When active, this annunciates when the current on phase C exceeds a specified amount.
Relative Setpoint 5	Over V unbal	When active, this annunciates if the voltage unbalance exceeds a specified percentage.
Relative Setpoint 6	Over I 4	When active, this annunciates when I 4 exceeds a specified amount.
Relative Setpoint 7	Over I 5	When active, this annunciates when I 5 exceeds a specified amount.

NOTE

There is usually no need to change any of the Relative Setpoint modules' setup registers for normal operation of the meter.

See the *ION Reference* for more information on the Relative Setpoint module.

Fine Tuning Over Condition Monitoring

If you want to fine-tune over condition monitoring, the only setup registers you should change are *SusUntlON* and *SusUntlOFF*.

SusUntlON determines how long the modules wait after an over condition is detected before reporting it. This gives the monitored value a short period to correct itself before the event is registered with the module so that very brief over conditions are ignored. Similarly, *SusUntlOFF* is the amount of time a normal value must be present before the module considers normal operation to be restored. Both *SusUntlON* and *SusUntlOFF* values are entered in seconds (the default value for both is 30 seconds).



chapter
19

Power Availability

This chapter details your meter's power availability functionality and how to configure it.

In This Chapter

◆ Configuring Power Availability	178
Sag/Swell Module Configuration	178
Pausing and Resetting Power Availability	179
Using Vista	179
Using ION Setup	180
Using the Front Panel	181
◆ Viewing Availability	182
◆ Detailed Behaviour	183
Terminology	184

Configuring Power Availability

Power availability predicts, based on historical data, the probability that a specific power system will be functioning in its correct state at some point in the future. The availability calculation measures the time that power was available at the meter's monitoring point. This value can be used alone or incorporated with other reliability calculations.

Typically, a utility distribution system provides an availability of approximately 99.9%. Many applications require better availability than this: up to 99.9999% or better. At this level, the number of consecutive nines becomes difficult to determine at a glance. High levels of availability are commonly referred to as "Number of Nines". For example, 99.9% corresponds to three nines, while 99.9999% is six nines.

Once the meter is installed, the availability calculations must be reset to ensure valid time counts. Reset availability calculations in ION software or via the meter's front panel. You can also pause availability calculations for meter maintenance or decommissioning purposes (refer to "Pausing and Resetting Power Availability").

Your meter comes pre-configured with a power availability framework that provides reliability measurements using "number of nines" calculations.

NOTE

While the Availability Framework is pre-configured, the operation of this framework requires the correct configuration of the Sag/Swell module according to your meter's power supply and operating ranges. See the Power Quality chapter. See also the *ION Reference* for detailed descriptions of this module.

Sag/Swell Module Configuration

Your meter's power availability framework requires that the Sag/Swell module be configured to the limits of your meter's power supply specification. See the *ION Reference* for detailed information on the operation of the Sag/Swell module.

Operating ranges of the ION 7550 and ION 7650 are as follows. For the most current specifications, see your meter's Installation Guide.

Power Supply	Operating Range
ION 7550 (Standard)	85-240 VAC, $\pm 10\%$ 47-63 Hz or 110-330 VDC, $\pm 10\%$ 347 V L-N RMS /600 V L-L RMS
ION 7650 (Standard)	85-240 VAC, $\pm 10\%$ 47-63 Hz 110-330 VDC, $\pm 10\%$ 347 V L-N RMS /600 V L-L RMS

The ANSI C84.1 1989 standard recommends a Swell limit of 106% for Range B voltage levels, as well as a Sag limit of 88% for load voltages and 92% for the service entrance.

Pausing and Resetting Power Availability

The power availability framework in the meter allows you to pause or reset its operation.

Pausing - The availability framework allows a user to temporarily pause the meter uptime counter and ignore any meter downtime and disturbance time. This allows a user to decommission the meter without affecting the availability statistics. Availability statistics are also paused when the Availability framework is “turned off.” Use ION software.

Resetting - A meter is typically reset after installation to ensure valid time counts. Availability calculations are reset with the *Rst Avlty Stats* (Reset Availability Statistics) External Pulse module. Use ION software or the front panel.

NOTE

To ensure correct availability calculations, do not reset during a Sag or Swell.

Using Vista

Use Vista software to manually pause or reset availability calculations.

1. Open your meter in Vista and navigate to the Power Quality screen.
2. Click on the Power Quality Setup and Controls button.

Resetting Availability

Click the “Reset Availability Statistics button”. See below:

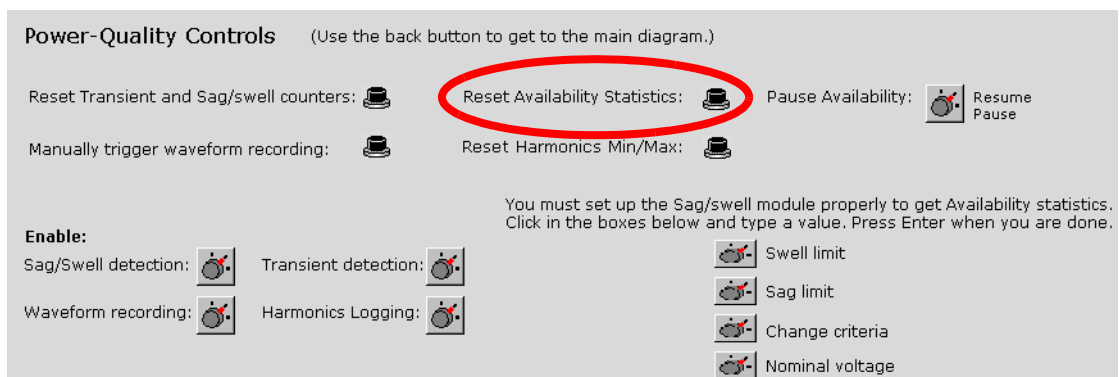

Pausing Availability

Click the “Pause Availability” switch. See below:



Using ION Setup

Reset availability calculations in ION Setup by clicking on the button labeled “# of 9s Reset” in the Verification > Normal Mode > Power Quality tab.

1. Open ION Setup and connect to your meter, using Basic Mode.
2. In the Setup Assistant, navigate to the Verification folder. Double-click Normal Mode.
3. In the Normal Mode screen, click the Power Quality tab.
4. In the Power Quality screen, click the button labeled “# of 9s Reset” to reset availability calculations. Provide a password (if requested), and click OK.

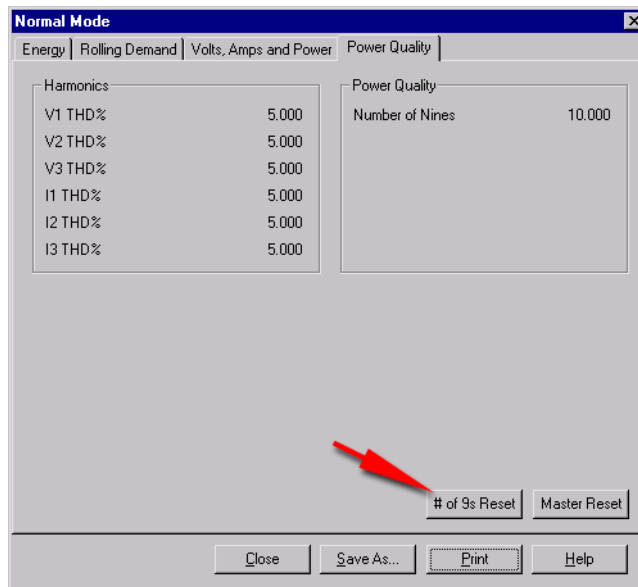

Using the Front Panel

Use the meter's front panel to reset availability calculations.

1. Access the Setup screen on your meter's front panel.
2. Scroll to the Meter Resets setting and select it.
3. Select User Resets.
4. Select Availability Reset. The Enter Password window appears.
5. Enter your password.
6. Select Confirm. A window with "Reset Successful" appears and the word "Pulsed" appears beside the Availability Reset setting on the User Resets screen.

Viewing Availability

The following power availability values display on the meter's front panel, and are viewable in Vista or ION Setup software:

- ◆ **Number of Nines:** the number of consecutive nines that appear in the most-significant digits of the availability value (e.g. "10" on the front panel indicates 10 nines: 99.99999999).
- ◆ **Availability-ppm:** the fraction of time that the power is available, in parts per million (ppm).
- ◆ **Evaluation Time (days):** the number of days that have elapsed since the calculation was last reset. This gives an indication of the time interval over which the availability calculation is made.

The availability framework is found at this location within Designer: Advanced Setup\Power Quality Framework\Power Availability Framework.

Detailed Behaviour

The Availability framework measures Disturbance time from the Sag/Swell module, Uptime from a counter module and meter Downtime from the Diagnostics module. Meter Downtime is added to the Uptime count to provide the total time of observation.

The meter uses three measurements when calculating the availability:

1. **Meter Uptime:** the time the meter is powered and actively monitoring. The time is measured by counting 1-second pulses from a periodic timer module.
2. **Meter Downtime:** this time is measured by the meter's internal clock and made available through the diagnostics module. The diagnostics module downtime register is updated on each power up. This calculation is accurate across a single month boundary: any additional month boundaries are assumed to have 30 days. You must set the Sag limit above the minimum voltage level specific to the power supply and wiring configuration of the meter. If there is no control power then it is assumed there is no power anywhere, and this time counts against availability.

When the meter powers up, it takes about 15 seconds before the ION modules are operational again. This power up time counts against the availability (a single power up per year limits total availability to 6 nines). If the application requires better resolution than this, then a UPS or other auxiliary power supply for the meter should be considered.

If the meter or control power circuit is taken out of service for maintenance, you can disable the measurement of meter downtime with ION software; see "Pausing Availability".

Number of Nines	ppm (% x 10,000)	Downtime (seconds/year)	Downtime per year
1	90%	3153600	36.5 days
2	99%	315360	3.7 days
3	99.9%	31536	8.8 hours
4	99.99%	3153.6	52.6 minutes
5	99.999%	315.36	5.3 minutes
6	99.9999%	31.536	31.5 seconds
7	99.99999%	3.153599998	3.2 seconds
8	99.999999%	.3153599998	.32 seconds
9	99.9999999%	.03153599998	.032 seconds
10	99.99999999%	.003153599998	.0032 seconds

3. **Voltage Disturbance Duration:** the total number of seconds that the voltage was outside the envelope determined by the Sag/Swell module. If several sags or swells occur during one second, only the last one counts toward the total. The Sag/Swell module settings may be used to control the voltage tolerance. If the Sag/Swell module is not enabled, no voltage disturbances are counted.

Terminology

- ◆ **Meter uptime:** the time the meter is powered and actively monitoring. The time is measured by counting 1-second pulses from a periodic timer module.
- ◆ **Meter downtime:** the time the meter is not powered. This time is measured by the meter's internal clock and made available through the diagnostics module. The diagnostics module downtime register is reset at the beginning of each outage.
- ◆ **Availability:** the probability of finding a system in the operating state at some time into the future. Availability is calculated as:

$$\begin{aligned} \text{Availability} &= \frac{\text{Time the power system is operating within specifications}}{\text{Total time of operation}^*} \\ &= \frac{\text{Meter uptime} - \text{disturbance time}}{\text{Meter uptime} + \text{meter downtime}} \end{aligned}$$

* Where total time of observation = uptime + meter downtime

- ◆ **Unavailability:** calculated in the framework and then converted to number of nines, and Availability in percent and parts per million (ppm):

$$\begin{aligned} \text{Unavailability} &= \frac{\text{Time the power system is operating outside specifications}}{\text{Total time of operation}^*} \\ &= \frac{\text{Disturbance time}}{\text{Meter uptime} + \text{meter downtime}} \end{aligned}$$

* Where total time of observation = uptime + meter downtime



chapter
20

Reporting

This chapter provides instructions for viewing various meter logs.

In This Chapter

◆ Introduction	186
◆ Viewing Meter Logs	186
Using the Front Panel	186
Using ION Setup	186
Using Vista	187

Introduction

Accumulated meter values are saved in logs. These **logs** are acquired by your energy management software (ION Enterprise or third-party) and saved in its database for analysis and reporting.

The Reporter component of ION Enterprise is a database reporting application that lets you define, generate, and manage comprehensive **reports** based on the information in your system database. It processes selected data and generates a finished report in Microsoft Excel 2000 format.

For more information on reports, see the Reporter section of the online *ION Enterprise Help*.

Viewing Meter Logs

View meter logs using ION software or the front panel.

Using the Front Panel

You can only display the Event Log using the front panel. Press the Events softkey to view.

Using ION Setup

Display various meter logs using the Report Assistant.

1. Open ION Setup and connect to your meter, using Basic Mode.
2. In the Setup Assistant, navigate to the Reports folder.

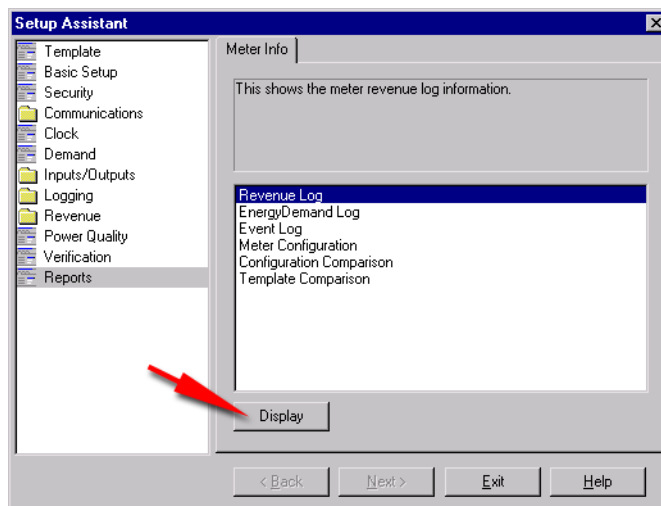

3. Select one of the logs or comparisons in the list and click Display to view the associated log.

Below is an example of a Revenue Log.

Date/Time	kWh del int	kVARh del int	kWh rec int	kVARh rec int
12/08/2004 2:00:00.000 PM	0.281062	0.117170	0.000000	0.000000
12/08/2004 2:15:00.000 PM	0.359765	0.150036	0.000000	0.000000
12/08/2004 2:30:00.000 PM	0.359810	0.150010	0.000000	0.000000
12/08/2004 2:45:00.000 PM	0.359727	0.150057	0.000000	0.000000
12/08/2004 3:00:00.000 PM	0.359817	0.150008	0.000000	0.000000
12/08/2004 3:15:00.000 PM	0.359747	0.150044	0.000000	0.000000
12/08/2004 3:30:00.000 PM	0.359823	0.150006	0.000000	0.000000
12/08/2004 3:45:00.000 PM	0.359756	0.150039	0.000000	0.000000
12/08/2004 4:00:00.000 PM	0.359779	0.150031	0.000000	0.000000
12/08/2004 4:15:00.000 PM	0.359802	0.150015	0.000000	0.000000
12/08/2004 4:30:00.000 PM	0.359763	0.150039	0.000000	0.000000
12/08/2004 4:45:00.000 PM	0.359809	0.150012	0.000000	0.000000
12/08/2004 5:00:00.000 PM	0.359738	0.150050	0.000000	0.000000
12/08/2004 5:15:00.000 PM	0.359810	0.150012	0.000000	0.000000
12/08/2004 5:30:00.000 PM	0.359765	0.150034	0.000000	0.000000
12/08/2004 5:45:00.000 PM	0.359784	0.150027	0.000000	0.000000
12/08/2004 6:00:00.000 PM	0.359787	0.150020	0.000000	0.000000
12/08/2004 6:15:00.000 PM	0.359793	0.150023	0.000000	0.000000

- You can view, save or print the log. Click Close to exit.

Using Vista

Open your meter in Vista and click on the System & Logs tab. Click a grouping object to view the associated logs. The following logs are available:

- ◆ Voltage
- ◆ Current
- ◆ Power
- ◆ Power Factor / Frequency
- ◆ Revenue Data
- ◆ Meter events

70000-0248-00

Revision Date: Aug. 31, 2004